



K A C O 
new energy.

KACO blueplanet 15.0TL3
KACO blueplanet 20.0TL3

Manual

■ English translation of German original

 **Authorised electrician**

Important safety instructions

These instructions form part of the product and must be carefully read, observed and stored in a place which is freely accessible at all times.

Legal provisions

The information contained in this document is the property of KACO new energy GmbH. Publication, in whole or in part, requires the written permission of KACO new energy GmbH.

KACO warranty

For current warranty conditions contact your system integrator. <http://www.kaco-newenergy.com>

Definitions on product designations

In these operating instructions, the product "Photovoltaic feed-in inverter" is referred to as "device" for ease of reading.

Trademarks

All trademarks are recognised, even if not explicitly identified as such. A lack of identification does not mean that a product or designation/logo is free of trademarks.

Photovoltaic feed-in inverter

Table of contents

1	General information	4	8.2	Preconditions relating to standards	32
1.1	About this document	4	9	Configuration and operation	33
1.2	More information	4	9.1	Initial start-up	33
1.3	Layout of Instructions	5	9.2	Controls	33
1.4	Identification.....	6	9.3	User interface	35
1.5	Warnings on the device	6	9.4	Menu structure.....	36
1.6	Target group	6	9.5	Monitoring the device	53
2	Safety	7	9.6	Performing a firmware update	55
2.1	Proper use.....	7	9.7	Access via Modbus.....	56
2.2	Protection features	8	10	Specifications.....	57
3	Description of the device	9	10.1	Reactive power control.....	57
3.1	Mode of operation.....	9	10.2	Active power regulation	60
3.2	Device diagram	9	10.3	FRT	65
3.3	System layout	11	10.4	Other grid-supporting functions that are effective in the case of active power	69
4	Technical data	12	10.5	Advanced islanding detection.....	71
4.1	Electrical data	12	10.6	Behavior in case of communication failure ...	72
4.2	General Data.....	13	11	Maintenance and troubleshooting.....	73
4.3	Environmental data	13	11.1	Visual inspection	73
5	Transportation and Delivery	15	11.2	Cleaning	73
5.1	Scope of delivery.....	15	11.3	Replacing the fan	74
5.2	Transporting the device	15	11.4	Shutting down for maintenance / troubleshooting	75
5.3	Installation tool.....	15	11.5	Overvoltage protection.....	76
6	Assembly and preparation.....	16	11.6	Faults	77
6.1	Choosing the installation location	16	11.7	Fault messages.....	78
6.2	Unpacking the device.....	17	11.8	Troubleshooting.....	79
6.3	Fastening the mount.....	18	12	Decommissioning and dismantling.....	90
6.4	Installing and securing the device.....	19	12.1	Switching off the device	90
7	Installation	21	12.2	Disconnecting connections	90
7.1	Opening the device	21	12.3	Uninstalling the device	91
7.2	Surveying the connection area	21	12.4	Disassembling the device.....	91
7.3	Making the electrical connection	21	12.5	Packaging the device	91
7.4	Connecting the device to the power grid	22	12.6	Storing the device	92
7.5	Connect PV generator to device	23	13	Disposal	93
7.6	Inserting the overvoltage protection.....	26	14	Service and warranty	94
7.7	Creating equipotential bonding	27	15	Appendix	95
7.8	Connecting the interfaces.....	28	15.1	EU Declaration of Conformity.....	95
7.9	Sealing the connection area	31			
8	Commissioning	32			
8.1	Requirements	32			

1 General information

1.1 About this document



! WARNING

Improper handling of the device can be hazardous!

1. You must read and understand the operating instructions in order to install and use the device safely!

Other applicable documents

During installation, observe all assembly and installation instructions for components and other parts of the system. These instructions also apply to the equipment, related components and other parts of the system.

Some of the documents which are required to register your system and have it approved are included with the operating instructions.

Storing the documents

These instructions and other documents must be stored near the system and be available at all times.

- The current version of the operating Instructions can be downloaded from www.kaco-newenergy.com.

English translation of German original

This document has been produced in several languages. The German-language version is the original version. All other language versions are translations of the original version.

This document is valid for the following types of device from firmware version V5.56 onwards

Type designation [KACO article No.]		
	KACO blueplanet 15.0 TL3 M2 WM OD IIGO	[1001614; 1001674; 101853]
	KACO blueplanet 20.0 TL3 M2 WM OD IIGO	[1001453; 1001615; 1001673; 1001831; 1001843; 1001854]
	KACO blueplanet 20.0 TL3 M2 WM OD JPGX	[1001631]

1.2 More information

Links to more detailed information can be found at www.kaco-newenergy.com

Document title	Document type
Technical data sheet	Product flyer
Remote access via web interface	Application note - operation
Grid and system protection	Application note
Powador-protect operating instructions	
Modbus protocol	Application note
RS485 protocol reactive power control	
SunSpec Information Model Reference	Excel files for software version with application note "Modbus protocol" under https://kaco-newenergy.com/downloads/
SunSpec Information Model Reference KACO	
Software package	Files for current software

Document title	Document type
EU Declaration of Conformity Country-specific certificates Certification for specific subassembly	Certificates

1.3 Layout of Instructions

1.3.1 Symbols used

	General hazard		Fire and risk of explosion
	Electrical voltage		Risk of burns
	Earthing - ground conductor		

1.3.2 Safety warnings symbols guide

 **DANGER**
High risk
 Failure to observe this warning will lead directly to serious bodily injury or death.

 **WARNING**
Potential risk
 Failure to observe this warning may lead to serious bodily injury or death.

 **CAUTION**
Low-risk hazard
 Failure to observe this warning will lead to minor or moderate bodily injury.

 **CAUTION**
Risk of damage to property
 Failure to observe this warning will lead to property damage.

1.3.3 Additional information symbols

 **NOTE**
Useful information and notes
 Information that is important for a specific topic or objective, but that is not safety-relevant.

1.3.4 Symbols for instructions

- ↻ Prerequisite for use
 1. Carry out the next step
 2. Additional action sequence
 - ⇒ Interim result of the action
 - ⇒ End result

1.4 Identification

You will find the name plate with the following data for service and other requirements specific to installation on the right side panel of the product:

- Product name
- Part no.
- Serial number
- Date of manufacture
- Technical data
- Disposal information
- Certification marking, CE marking.

KACO 		KACO blueplanet 20.0 TL3 M2 WM OD IKO	
Part number 1081723		Serial number 20.0TL3M2WM000000 Year Q4 / 17	
KACO new energy GmbH Hofmannstr. 1 42699 Solingen Made in Germany			
Input	V _{max} PV / I _{sc} PV (max) / I _{nom} PV V-MPP at P _{nom} / V _r -range	1100 VDC 2x 32 A / 220 A 515 V - 800 V / 200 V - 950 V	
Output	Nominal voltage	220 V / 380 V (3N/PE) 230 V / 400 V (3N/PE)	
	Voltage range continuous operation	184 V - 284 V (P5-N)	
	Current (maximum continuous)	3 x 31 A	
	Frequency range	42 Hz - 68 Hz	
Output Power	Rated power / maximum power	20 000 VA / 20 800 VA	
	Reactive power / cos phi	0-100 %S _{nom} / 1 - 0.3 ind/cap	
Environment	Temperature range	-25 °C...+60 °C	
	Protection class / ingress protection	1 / IP65	
ABC-fault circuit protection none		 	
Interface protection according to country specific requirements, detail see manual			
No galvanic separation / UTILITY-INTERCONNECTED			

Fig. 1: Name plate

1.5 Warnings on the device

A warning sticker is affixed to the device. Read the warnings carefully.

Do not remove the sticker. If the sticker is missing or is illegible, please contact a KACO representative or distributor.

- Article number: 22000270

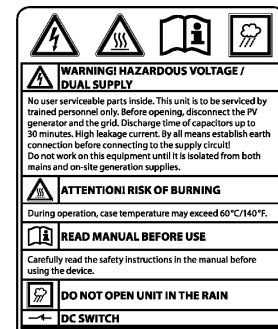

Fig. 2: Warning sticker

1.6 Target group

All activities described in the document may only be carried out by specially trained personnel with the following qualifications:

- Knowledge about how an inverter functions and operates
- Knowledge of the Modbus specifications
- Knowledge of the SunSpec Modbus specifications
- Training in the handling of hazards and risks during the installation and operation of electrical devices and systems.
- Education concerning the installation and start-up of electrical units and plants.
- Knowledge of applicable standards and directives.
- Knowledge and adherence to this document with all safety notices.

2 Safety



⚠ DANGER

Lethal voltages are still present in the connections and cables of the device even after the device has been switched off and disconnected!

Severe injuries or death may occur if the cables and/or terminals/busbars in the device are touched.

1. Comply with all safety regulations and current technical connection specifications of the responsible power supply company.
2. The device is only permitted to be opened or serviced by a qualified electrician.
3. Switch off the grid voltage by turning off the external circuit breakers.
4. Do not touch the cables and/or terminals/busbars when switching the device on and off.
5. Keep the device closed when in operation.

The electrician is responsible for observing all existing standards and regulations. The following applies:

- Keep unauthorised persons away from the device and/or system.
- In particular, making sure that the locally applicable version of the standard ¹ "Requirements for special installations or locations – solar photovoltaic (PV) power supply systems" is observed.
- Ensure operational safety by providing proper grounding, conductor dimensioning and appropriate protection against short circuiting.
- Observe all safety instructions on the product and in these operating instructions.
- Switch off all voltage sources and secure them against being inadvertently switched back on before performing visual inspections and maintenance.
- When taking measurements on the live device:
 - Do not touch the electrical connections
 - Remove all jewellery from wrists and fingers
 - Ensure that the testing equipment is in safe operating condition.
- Modifications to the surroundings of the device must comply with the applicable national and local standards.
- When working on the PV generator, in addition to disconnecting this from the grid it is also necessary to switch off the DC voltage using the DC isolator switch on the device.

2.1 Proper use

The device is a transformerless PV inverter which converts the direct current of the PV generator into grid-compatible three-phase alternating current and then feeds the three-phase alternating current into the public power grid.

The device is built using state-of-the-art technology and in accordance with the recognized safety rules. Nevertheless, improper use may cause lethal hazards for the operator or third parties, or may result in damage to the product and other property.

The device is intended for indoor and outdoor applications and may only be used in countries for which it has been approved or for which it has been released by KACO new energy and the grid operator.

Operate the device only with a permanent connection to the public power grid. The country and grid type selection must be commensurate with the respective location and grid type.

The requirements of the grid operator must be met for grid connection to take place. The permission of the relevant authorities may also be required in order to secure authorisation to connection to the grid.

¹ Country	Standard
EU	Harmonised document - HD 60364-7-712 (European implementation of the IEC standard)
USA	PV section of NEC 690 and sections in article 100, 690.4, 690.6 and 705.10

Tab. 1: Examples of standards specific to business premises

The name plate must be permanently attached to the product and must be in legible condition.

Any other or additional use is not considered proper or intended use and can lead to an annulment of the product guarantee. This includes:

- Use of a distribution system that is not described (grid type)
- Use of sources other than PV-strings.
- Mobile use
- Use in rooms where there is a risk of explosion
- Use in direct sunlight, rain or a storm or other harsh environmental conditions
- Outdoor use in environmental conditions that exceed the limits stated in the technical specifications >Environmental data.
- Operation outside the specification intended by the manufacturer
- Overvoltage on the DC connection of over 1,000 V
- Device modification
- Standalone mode

2.2 Protection features

The following monitoring and protection functions are integrated in the device:

- RCMU (Residual Current Monitoring Unit)
- Overvoltage conductor / varistor to protect the power semiconductors from high-energy transients on the grid and generator sides.
- Device temperature monitoring system
- EMC filter to protect the inverter from high-frequency grid interference
- Grid-side varistors grounded to earth to protect the product against burst and surge pulses
- Anti-islanding detection according to the current standards.
- Isolation detection / residual current monitoring and disconnection function to detect isolation faults



NOTE

If the device is connected, the overvoltage conductors / varistors contained in the device have an impact on the electrical system insulation resistance test as per HD 60364-6 / IEC 60364-6 Low-voltage installations- Part 6: Verification.

IEC 60364-6 6.4.3.3 describes two options for this case. The first option is to disconnect devices with an overvoltage conductor or, if this is not practicable, then the test voltage can be reduced to 250V.

3 Description of the device

3.1 Mode of operation

The device converts the DC voltage generated by the PV-modules into AC voltage and feeds this into the power grid. The starting procedure begins when there is sufficient sunlight and a specific minimum voltage is present in the device. The feed-in process begins once the PV generator has passed the insulation test and the grid parameters are within the requirements imposed by the grid operator for a specific monitoring time. If, as it gets dark, the voltage drops below the minimum voltage value, feed-in mode ends and the device switches off.

3.2 Device diagram

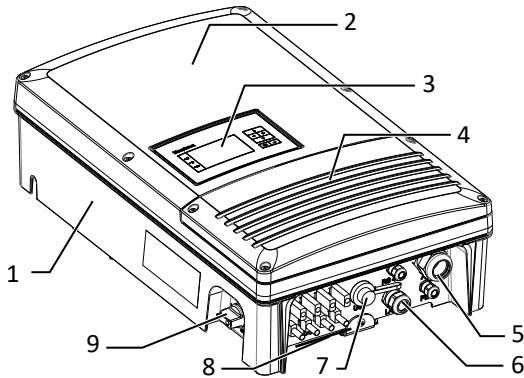

Fig. 3: Device diagram

Key

1 Housing	6 Interfaces / cable feed-through
2 Cover	7 Communication - USB port / cable feed-through
3 Status indicator with display and operator panel	8 DC connection / DC connector
4 Cover for the connection area	9 DC isolator switch
5 AC connection / cable feed-through	

3.2.1 Mechanical Components

The DC disconnector is located on the left side of the unit. The DC isolating switch is used to disconnect the inverter from the PV generator when servicing is required.

Disconnecting the device from the PV generator

☞ Switch the DC isolator switches from 1 (ON) to 0 (OFF).

Connecting the device to the PV generator

☞ Switch the DC isolator switches from 0 (OFF) to 1 (ON).

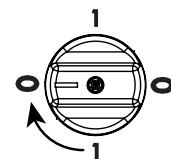

Fig. 4: DC isolator switch

3.2.2 Electrical functions

A potential-free relay contact is integrated into the device. Use this contact for one of the following functions:

Potential-free relay

The potential-free relay contact closes as soon as there is a fault during operation. You use this function, for example, to signal a fault visually or acoustically.

Priwatt

The energy that is provided by the PV system can be put to use directly by the appliances that are connected in your home.

The potential-free contact can switch larger appliances (e.g. air conditioning units) on and off with the Priwatt function activated. This requires an external power supply and an external load relay.

When the function is active, either the remaining runtime (in hours and minutes) or the shutdown threshold (in kW) is displayed on the start screen depending on the operating mode selected. The “priwatt” function is not active in the unit’s delivery state. The option can be configured in the Settings menu.

3.2.3 Interfaces

You can configure the interfaces and the web server in the Settings menu. The device has the following interfaces for communication and remote monitoring.

Ethernet interface

Monitoring can occur directly on the unit using the integrated Ethernet interface. A local web server is installed in the unit for this purpose. This can also be used to request measured values remotely.

For monitoring a system comprising several inverters, we recommend you use an external data logging and monitoring system.

RS485 interface

Use this monitoring option if you cannot check the functioning of the system on-site on a regular basis, e.g. if your place of residence is located a great distance from the system. To connect the RS485 interface, contact your authorised electrician.

For monitoring your PV system using the RS485 interface, KACO new energy GmbH offers monitoring devices.

USB interface

The USB connection of the device is a type A socket. It is located on the underside of the housing and is protected by a safety cover. The USB connection is specified to draw 500 mA of current.

Use the USB interface to read out stored operating data, load firmware updates or device configurations using a FAT32-formatted USB stick.

„Inverter Off“ Eingang / DRMO for Australia

In addition to the safety functions, the internal interface switches can also be actuated via the "Inverter Off" input.

The Powador-protect or a protective device from another manufacturer can be used for this purpose.

If a Powador-protect is used as the central interface protection, the fail-safe disconnection of suitable KACO inverters from the public grid can be carried out by the internal interface switches instead of separate interface switches. This requires the inverters in the photovoltaic system to be connected to the Powador-protect.

Information on installation and use can be found in this manual, in the Powador protect manual and in the instructions for use of the Powador protect on the KACO web site.

On the "Inverter Off" input, instead of the Powador-protect an interface protection device from another supplier can also be connected to actuate the internal interface switches.

Digital inputs

You can extend the unit with additional digital inputs by means of an extension module (available from KACO customer service). This can be used to connect a ripple control receiver or a protective shutdown system.

3.3 System layout

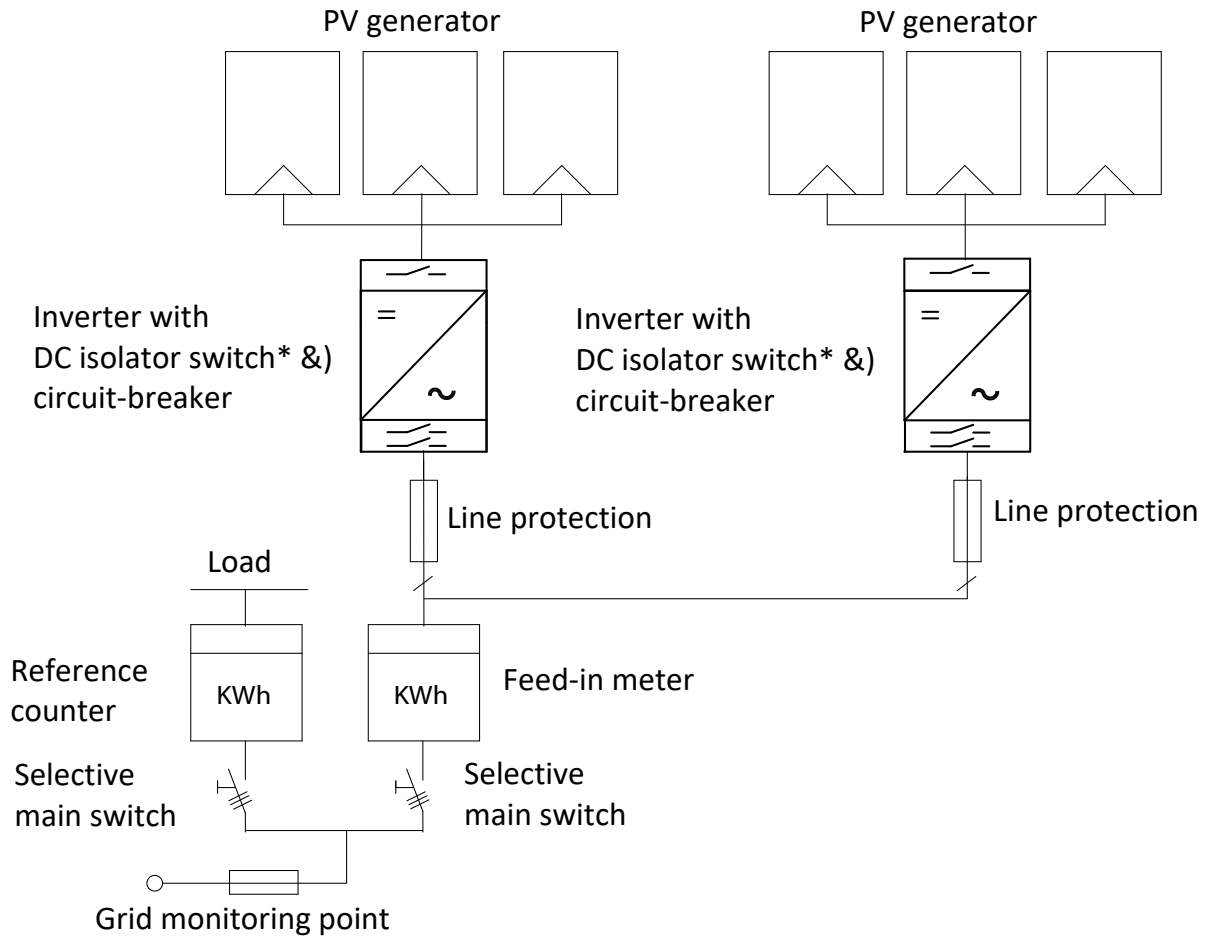

Fig. 5: Circuit diagram of a system with two inverters

Key	Definition / information on the connection
PV generator	The PV generator converts the radiant energy of sunlight into electrical energy.
Inverter with circuit-breaker	The PV generator is connected to the device's DC connection.
Line protection	The circuit breaker is an overcurrent protection device.
Feed-in meter	The feed-in meter is to be specified and installed by the power supply company. Some power supply companies also allow the installation of your own calibrated meters.
Selective main switch	The selective main switch is to be specified by the power supply company.
Reference counter	The reference counter is to be specified and installed by the power supply company. This measures the amount of energy drawn.
DC isolator switch	Use the DC isolator switch to disconnect the device from the PV generator.

4 Technical data

4.1 Electrical data

	blueplanet 15.0 TL3 M2 WM OD IIG0	blueplanet 20.0 TL3 M2 WM OD IIG0
DC Input levels	Input levels (DC)	
Maximum recommended PV generator power	18 kW	24 kW
MPPrange@Pnom	420-800 V	515-800 V
Working range	200 V -950 V	
Rated voltage	673 V	
Starting voltage	250 V	
Open circuit voltage	1,000 V	
Max. input current ²	2 x 20 A	
Number of strings	2 x 2	
Number of MPP controls	2	
Max. short-circuit current (ISC max.)	2 x 32 A	
Input source feedback current	0 A	
Polarity safeguard	yes	
String fuse	no	
DC overvoltage protection	Base	

	blueplanet 15.0 TL3 M2 WM OD IIG0	blueplanet 20.0 TL3 M2 WM OD IIG0
AC Output levels	Output levels (AC)	
Nominal power	15.0 kVA [@240V]; 15.0 kVA [@230V]; 15.0 kVA [@220V]	20.0 kVA [@220V]; 20.0 kVA [@230V]; 20.0 kVA [@240V]
Rated voltage	220 V / 380 V [3/N/PE]; 230 V / 400 V [3/N/PE]; 240 V / 415 V [3/N/PE]	220 V / 380 V [3/N/PE] 230 V / 400 V [3/N/PE] 240 V / 415 V [3/N/PE] 277 V / 480 V [3/N/PE]
Voltage range: continuous operation	305 V - 480 V (Ph-Ph)	
Rated current	3x 20.9 A [@415V]; 3x 21.7 A [@400V]; 3x 22.8 A [@380V]	3x 27.9 A [@415 V]; 3x 28.9 A [@400V]; 3x 30.4 A [@380 V]
Max. continuous current	3 x 23.0 A	3 x 31.0 A
Contribution to peak short-circuit current ip	44.96 A	61.16 A
Initial short-circuit alternating current (Ik" first single period effective value)	24.29 A	33.66 A
Short circuit current continuous [ms] (max output fault current)	27.6 A	

² The "Max. input current" is the maximal theoretical value for operation with full power when the feed-in power is low. The device is limited to the maximum AC power.

The "Max. short-circuit current (ISC_{max})" defines together with open circuit voltage (U_{DCmax}) the characteristic of the connected PV generator. This is the relevant value for string sizing and is the absolute maximal limit for inverter protection. The connected PV-Generator must be designed, that the max short circuit current is below or equal to of the inverter ISC_{max} of the inverter under all foreseeable conditions. In no condition the design may result in a greater short circuit current than ISC_{max} of the inverter [See section 7.5.4 Page 25].

	blueplanet 15.0 TL3 M2 WM OD IIG0	blueplanet 20.0 TL3 M2 WM OD IIG0
Inrush current	3.4 A [RMS (20ms)]	2.41 A [RMS (20ms)]
Rated frequency	50/60 Hz	
Frequency range	42 - 68 Hz	
Reactive power	0-100 % Snom	
cos phi	0.3 - 1 ind/cap	
Number of feed-in phases	3	
Distortion factor (THD)	<0.7 %	<0.5 %
Max. voltage range (up to 100 s)	520 V (Ph-Ph)	
AC overvoltage protection	no	

4.2 General Data

	blueplanet 15.0 TL3 M2 WM OD IIG0	blueplanet 20.0 TL3 M2 WM OD IIG0
General electrical data		
Max. efficiency	98.02 %	98.40 %
European efficiency	97.60 %	98.10 %
Self consumption: Standby	1.5 W	
Feed-in from	20 W	
Transformer unit	no	
Protection class / over voltage category	I / III	
Grid monitoring	Country-specific	
Distribution system	TN-C-System, TN-C-S-System, TN-S-System, TT-System	

	blueplanet 15.0 TL3 M2 WM OD IIG0	blueplanet 20.0 TL3 M2 WM OD IIG0
General Data		
Display	Graphical display 240 x 128 pixels + LEDs	
Controls	4-way button + 2 buttons	
Menu languages	DE; EN; FR; IT; ES; PL; NL; PT; CZ; HU; SL; TR; RO	
Interfaces	2 x Ethernet, USB, RS485, error relay 4 x digital inputs (optional)	
Communication	TCP/IP, Modbus TCP, Sunspec	
Potential-free relay	Potential-free NO contact (make contact), max. 30 V/1 A	
DC isolator switch	yes	
AC isolator switch	no	
Cooling	temp. controlled fan	
Number of fans	1	
Noise emission	< 52 / noiseless without fan operation db(A)	< 53 / noiseless without fan operation db(A)
Housing material	Cast aluminium	
HxWxD	690 mm x 420 mm x 200 mm	
Weight	48 kg	46.6 kg
Certifications	Overview: see homepage / download area	

4.3 Environmental data

	blueplanet 15.0 TL3 M2 WM OD IIG0	blueplanet 20.0 TL3 M2 WM OD IIG0
Installation height	2,000 m	
Installation distance from coast	>2000 (art.1001614) >500 (art. 1001674)	>2000 (art.1001615) >500 (art. 1001673)
Ambient temperature	-25 °C - +60 °C	

	blueplanet 15.0 TL3 M2 WM OD IIG0	blueplanet 20.0 TL3 M2 WM OD IIG0
Power derating from	50 °C	40 °C
Protection rating (KACO installation location)	IP65	
Humidity range (non-condensing) [%]	0 to 95 %	

5 Transportation and Delivery

Every product leaves our factory in perfect electrical and mechanical condition. Special packaging ensures that the devices are transported safely. The shipping company is responsible for any transport damage that occurs.

5.1 Scope of delivery

- Inverter
- Mount
- Installation kit
- Manual [online] / operating instructions [multi-language]

Check the equipment included

1. Inspect the device thoroughly.
2. Immediately notify the shipping company in case of the following:
 - Damage to the packaging that indicates that the device may have been damaged.
 - Obvious damage to the device.
3. Send a damage report to the shipping company immediately.
4. The damage report must be received by the shipping company in writing within six days following receipt of the device. We will be glad to help you if necessary.

5.2 Transporting the device

⚠ CAUTION

Hazard due to impact; risk of breakage to the device!

1. Pack the device securely for transport.
2. Transport the device using the intended carrying handles of the packaging box.
3. Do not expose the device to any shocks.

For safe transportation of the product, use the hand recesses in the carton.

Packaging	Folding cardboard box
Packaging size	290 x 480 x 750 mm
Total weight, including packaging	52 kg

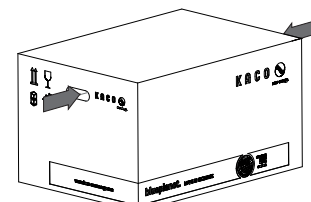

Fig. 6: Transporting the device

5.3 Installation tool

The codes given in the table below are used in all usage instructions for assembly/installation/maintenance and disassembly for the tools and tightening torques being used.

Code (s)	Shape of the connector
XW	External hexagon
XA	Internal hexagon
XT	Torx
XS	Slot

Tab. 2: Key and description of tool codes

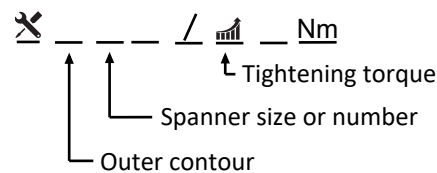

Fig. 7: Form pattern

6 Assembly and preparation

6.1 Choosing the installation location



⚠ DANGER

Risk of fatal injury due to fire or explosions!

Fire caused by flammable or explosive materials in the vicinity of the device can lead to serious injuries.

1. Do not mount the inverter in potentially explosive atmospheres or in the vicinity of highly flammable materials.

⚠ CAUTION

Property damage due to gases that have an abrasive effect on surfaces when they come into contact with ambient humidity caused by weather conditions.

The device housing can be seriously damaged due to gases in combination with air humidity resulting from weather conditions (e.g. ammonia, sulphur).

1. If the device is exposed to gases, the installation must be carried out at observable locations.
2. Perform regular visual inspections.
3. Immediately remove any moisture from the housing.
4. Ensure adequate ventilation at the installation location.
5. Immediately remove dirt, especially on vents.
6. Failure to observe these warnings may lead to device damage which is not covered by the manufacturer warranty.



NOTE

Access by maintenance personnel for service

Any additional costs arising from unfavourable structural or installation conditions will be billed to the customer

Installation space

- As dry as possible, climate-controlled, the waste heat must be dissipated away from the device.
- Unobstructed air circulation.
- When installing the device in a control cabinet, provide forced ventilation for sufficient heat dissipation.
- Close to the ground, accessible from the front and sides without requiring additional resources.
- Protected on all sides against direct weather exposure and sunlight (thermal heating) in outdoor areas. Implementation where necessary via constructional measures, e.g. wind breaks.

Installation surface

- Must have adequate load-bearing capacity
- Must be accessible for installation and maintenance
- Must be made out of heat-resistant material (up to 90 °C)
- Must be flame resistant
- Minimum clearances to be observed during installation: [See figure 13 [▶ Page 18]

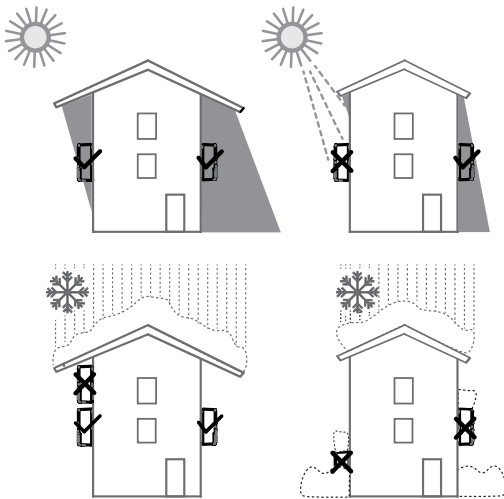

Fig. 8: Device for outdoor installation

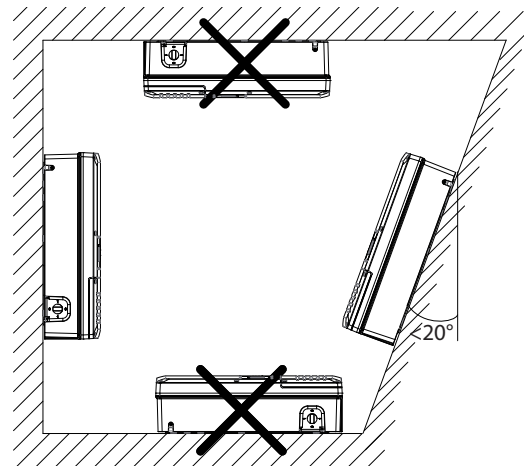

Fig. 9: Permissible installation location

6.2 Unpacking the device



CAUTION

Risk of injury caused by excessive physical strain

Lifting the device, for transport, relocation and assembly, can result in injuries (e.g. back injuries).

1. Only lift the device using the openings provided.
2. The device must be transported and installed by at least 2 persons.

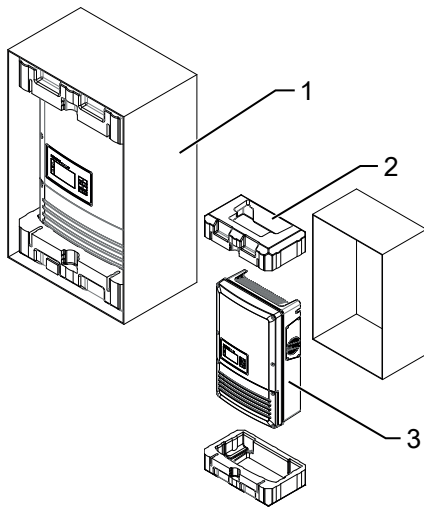

Fig. 10: Unpacking the device

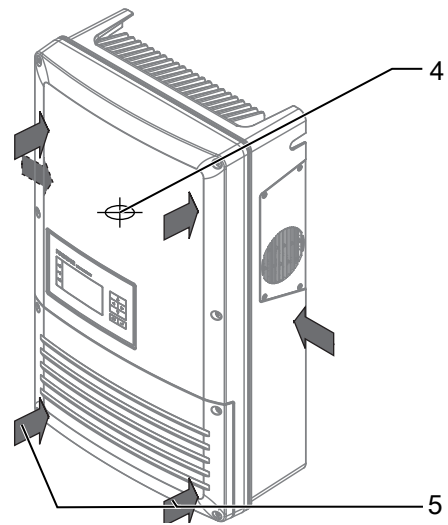

Fig. 11: Transporting the device

Key

1	Cardboard box cover	4	Centre of gravity of the device
2	Protective packaging	5	Lifting positions
3	Unit		

Unpacking the device

1. Loosen packaging tape from cardboard box.
2. Open carton at the front.
3. Remove installation material and documentation.
4. Reach behind the housing and slide the device to the side and out of the carton.
5. Remove upper and lower protective packaging from housing.

6. Place the protective packaging back into the carton.
 7. Lift the device at the intended positions.
- ⇒ Continue mounting the device.

6.3 Fastening the mount



⚠ WARNING

Hazard when using unsuitable fixing materials!

If unsuitable fixing materials are used, the device could fall and persons in front of the device may be seriously injured.

1. Use only fixing materials that are suitable for the mounting base. The fastening materials supplied are only to be used for masonry and concrete.
2. Only install the device in an upright position.

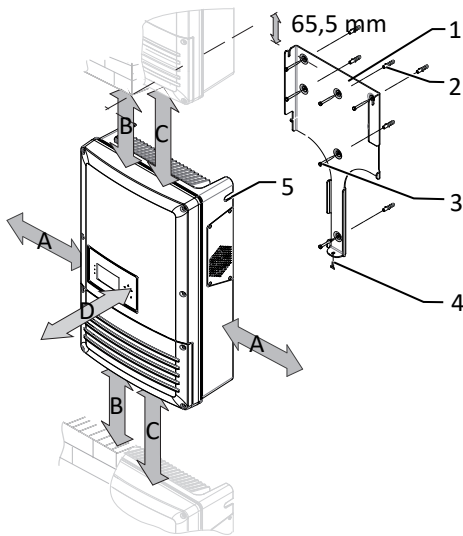

Fig. 12: Minimum clearances for wall mounting

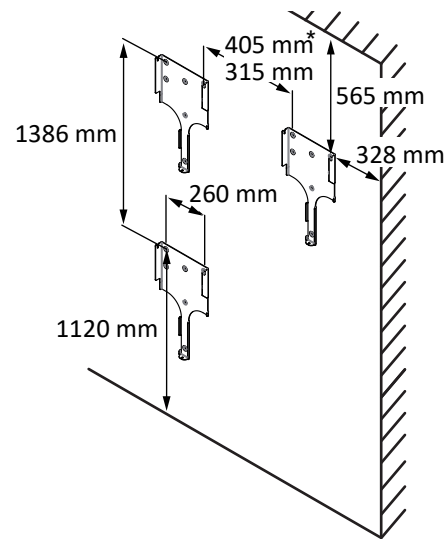

Fig. 13: Position of wall bracket / suspension

Key			
1	Mount	4	Screw for securing purposes (1x)
2	Fixings for mounting [S6 – Ø 6mm/ 60mm]	5	Bracket to prevent device displacement
3	Screw for mounting 5x 5x50 [Z2+Slot 5x50 [See section 6.3 Page 18]]		
A	Minimum clearance: 250 mm (without device 315 mm) recommended distance 405 mm (without device 340 mm *)	C	Minimum clearance: 700 mm
B	Minimum clearance: 500 mm	D	Recommended clearance: 250 mm

⊞ Cardboard packaging with mount and mounting kit removed from the packaging and opened.

1. Mark the mounting position on the wall surface according to the position of the mount by drawing a line.
2. Mark the positions of the drill holes using the slot in the mount.

. **NOTE: The minimum clearances between two devices, or the device and the ceiling or floor have already been taken into account in the diagram.**

3. Fix the mount to the wall using suitable mounting fixtures from the mounting kit.

. **NOTE: Make sure that the mount is oriented correctly.**

⇒ Proceed with the installation of the device.

6.4 Installing and securing the device



CAUTION

Risk of injury from improper lifting and transport.

If the device is lifted improperly, it can tilt and result in a fall.

1. Always lift the device vertically using the openings provided.
2. Use a climbing aid for the chosen installation height.
3. › Wear protective gloves and safety shoes when lifting and lowering the device.



NOTE

Power reduction due to heat accumulation!

If the recommended minimum clearances are not observed, the device may go into power regulation mode due to insufficient ventilation and the resulting heat build-up.

1. › Observe minimum clearances and provide for sufficient heat dissipation.
2. All objects on the device housing must be removed during operation.
3. › Ensure that no foreign bodies prevent heat dissipation following device installation.

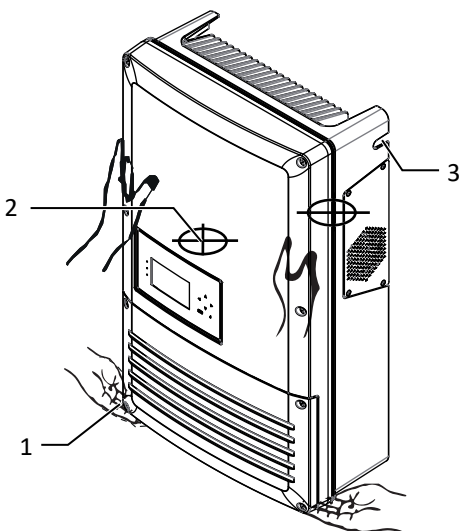

Fig. 14: Lift the device using the housing

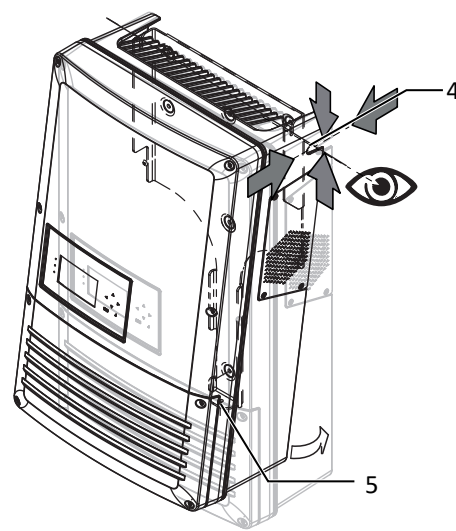



Fig. 15: Fitting the device onto the mount

Key

1	Opening	4	Interlock in mount
2	Centre of gravity	5	Fastening lug
3	Recess to allow visibility during mounting process		

Lifting and installing the device

⌚ The mount has been installed.

1. Lift the device using the lateral openings [See figure 14 [▶ Page 19]. Observe the device's centre of gravity!
2. Suspend the device in the mount using the recess on the rear of the device [See figure 15 [▶ Page 19]
3. Insert the screw provided into the lug of the mount and secure the device to prevent it from being lifted off  Z2 (Pozidrive) /  1 Nm] [See figure 12 [▶ Page 18].

• **NOTE: Alternatively: At this point, the screw described above can be replaced by a special screw as anti-theft protection.**

⇒ Device is installed. Proceed with the electrical installation.

⚠ CAUTION**Property damage as a result of condensation**

During pre-assembly of the devices, moisture can penetrate into the interior via the DC plug connectors and the dust-protected threaded connections. The resulting condensate can cause damage to the device during installation and start-up.

- ✓ Keep the device closed during pre-assembly and do not open the connection area until you perform installation.
- 1. Seal off any plug-in connections and screw fittings using sealing covers.
- 2. Prior to installation, check the inner area for condensation and if necessary, allow it to dry sufficiently before installation.
- 3. Immediately remove any moisture from the housing.

7 Installation

7.1 Opening the device



NOTE

Removing the upper housing cover will invalidate the warranty.

Only ever release and remove the lower housing cover. Opening the upper housing cover will invalidate your warranty.

- ⌚ The device has been installed on the mount.
 - ⌚ Wipe any moisture off the frame of the housing cover using a cloth.
 - 1. Undo the 4 screws (2) and carefully remove the housing cover (1) [X_T_30]
 - 2. Be careful not to damage or soil the seal when setting the housing cover down.
- ⇒ Proceed with the installation of the device.

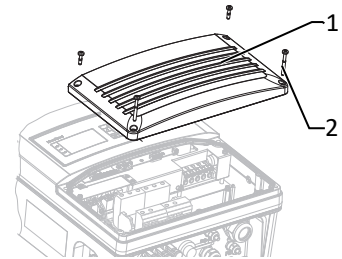

7.2 Surveying the connection area

The connection for the AC supply is located inside the housing. The DC input source is connected to the housing base via the solar plug connectors.

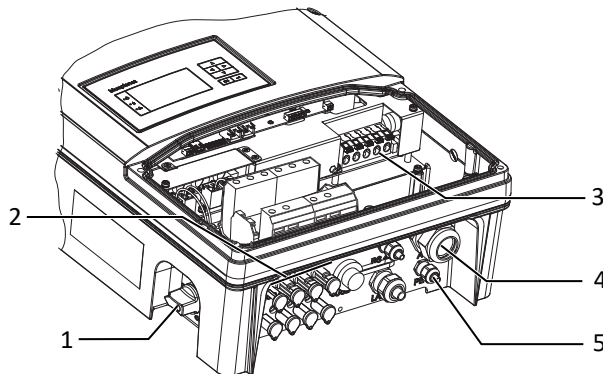

Fig. 16: Connection area

Key	
1	DC isolator switch
2	8 (2x4) MC-compatible DC connectors for PV generator
3	AC connection terminal
4	Cable fitting (M40) for AC connection
5	Cable fitting (M16) for housing ground connection

7.3 Making the electrical connection



NOTE

Select conductor cross-section, safety type and safety value in accordance with the following basic conditions:

Country-specific installation standards; power rating of the device; cable length; type of cable installation; local temperature

7.3.1 Requirement for supply lines and fuse



DC-side	
Max. conductor cross-section	dependent on the plug that is used
Min. cable cross-section	in accordance with local installation standards

DC-side	
Recommended cable type	Solar cable
AC-side	
Max. conductor cross-section	10 mm ²
Max. cable cross-section (without wire sleeves)	16 mm ²
Length of insulation to be stripped off	18 mm
Connection type	Spring-type terminals
Fuse protection for installation provided by customer	at least 32A at 6.0mm ²
Fitting for AC connection	M40
Cable diameter for cable fitting	16 - 28 mm
Torque for cable fitting	10 Nm
Interfaces	
Interface screw connections	Ethernet: M25, default RS485: M16, max. 1.5 mm
Cable diameter for cable fitting	(2x) 8 - 17 mm
RS485 connection type	spring-type terminal
RS485 terminal cable cross-section	0.25 - 1.5 mm ²
Ethernet connection type	RJ45
Torque for cable fitting	4 (M25) 1.5 (M16) Nm
Overvoltage protection	
Overvoltage protection for DC plug (integrated)	Type [KACO article no.] VAL-MS-T1/T2 1000DC-PV-ST - 2801162 [3010608] – SPD I + II
	VAL-MS 1000DC-PV-ST – 2800624 [23700379] – SPD II
Base integrated	VAL-MS/2+V-BE FM-PU40 – [2908425] – Phoenix Contact

7.4 Connecting the device to the power grid

7.4.1 Make the grid connection

TN-S system, TN-C-S system, TT system

- ⊖ Connection cable with 5 cores is available on the device.
- ⊖ Rated mains voltage corresponds to nameplate specification VAC nom.
 1. Loosen cable gland for AC connection. [W_46]
 2. Stripping AC cables.
 3. Insert AC cables through the cable gland into the connection area.
 4. Strip AC cables. [s.l 18 mm]
 5. Open the latch of the PCB terminal block.
 6. Insert the cables below the terminal block according to the labeling.
 7. Close the locking device of the PCB terminal block.
 8. Check all connected cables for tight fit.
 9. Tighten the cable gland. [W_46 /  10 Nm]
- ⇒ Make the mains connection.

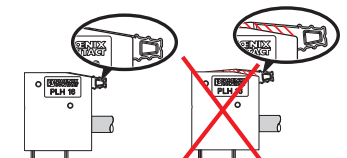
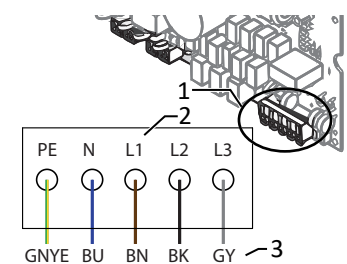

Fig. 17: AC connection terminal, 5-pin

- 1 Connection terminal
- 2 Labelling
- 3 Colour code

**NOTE**

An AC-side disconnection unit must be provided during the final installation stage. This disconnecter mechanism must be installed so that it can be accessed at any time without obstruction.

**NOTE**

If an external residual current circuit breaker is necessary due to the installation specification, a type A residual current circuit breaker must be used.

If the type A is used, the insulation threshold must be set to greater than/equal to (\geq) 200 kOhm in the "Parameters" menu [See [See section 9.4.1 ▶ Page 36]].

For questions regarding the appropriate type, please contact the installer or our KACO new energy customer service.

**NOTE**

When the line resistance is high, i.e. long cables on the grid side, the voltage at the grid terminals of the device will increase in feed-in mode. If the voltage exceeds the country-specific grid overvoltage limit value, the device switches off.

1. Ensure that the cable cross-sections are sufficiently large or that the cable lengths are sufficiently short.

7.5 Connect PV generator to device

7.5.1 Checking the PV generator for a ground fault

**DANGER****Risk of fatal injury due to electric shock!**

Severe injury or death will result if the live connections are touched. When there is sunlight present on the PV generator, there is DC voltage on the open ends of the DC cables.

1. Only touch the PV generator cables on the insulation. Do not touch the exposed ends of the cables.
2. Avoid short circuits.
3. Do not connect any strings with a ground fault to the device.

**NOTE**

The threshold value from which the insulation monitor reports an error can be set in the "Parameters" menu.

Ensure that there is no ground fault

1. Measure the DC voltage between the protective earth (PE) and the positive cable of the PV generator.
2. Measure the DC voltage between the protective earth (PE) and the negative cable of the PV generator.
 - ⇒ If stable voltages can be measured, there is a ground fault in the DC generator or its wiring. The ratio between the measured voltages gives an indication as to the location of this fault.
3. Rectify any faults before taking further measurements.
4. Measure the electrical resistance between the protective earth (PE) and the positive cable of the PV generator.
5. Measure the electrical resistance between the protective earth (PE) and the negative cable of the PV generator.
 - ⇒ In addition, ensure that the PV generator has a total insulation resistance of more than 2.0 MOhm, since the device will not feed in if the insulation resistance is too low.
6. Rectify any faults before connecting the DC generator.

7.5.2 Recommended standard connection

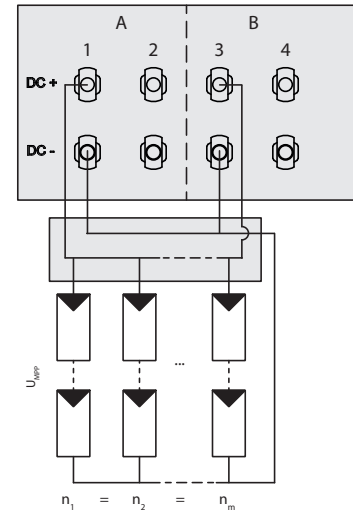
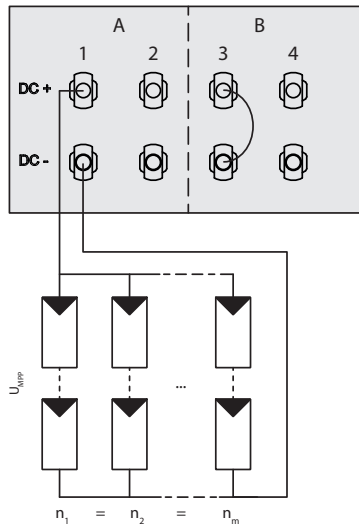
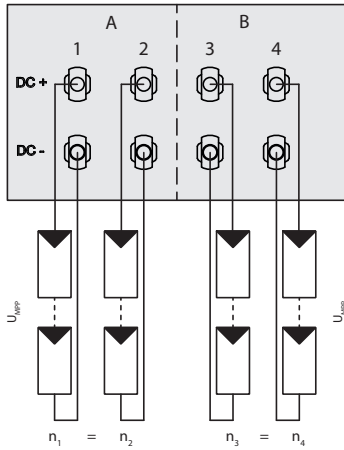

Fig. 18: Recommended standard connection

Fig. 19: Parallel input with Y-adapter, short-circuits the unused MPP Tracker B

Fig. 20: One generator parallel on both MPP trackers

Possible wiring variants		
2 PV generators for each MPP tracker	1 PV generator for one tracker. The second tracker is deactivated	1 PV generator parallel on both MPP trackers
The MPP voltages of the two DC strings can be different. They are supplied by separate, independently operating MPP trackers (MPP trackers A and B).	If one of the MPP trackers (A or B) is not used, then it must be short-circuited, otherwise faults can occur during the self-test of the unit and the feed-in operation is not guaranteed. The short-circuiting of an MPP tracker does not result in the device being damaged.	The DC inputs can also be connected in parallel. In this case, only lines with the same MPP voltage may be connected in parallel. ($U_{n1}=U_{n2}=U_{nm}$). The maximum permissible rated current (DC) doubles with parallel connection of both MPP trackers. In case of a parallel input connection, MPP trackers A and B must be bridged. Parallel operation is automatically recognised by the inverter
Number of modules per string: $n_1=n_2, n_3=n_4$	Number of modules per string: $n_1=n_2=n_m$	Number of modules per string: $n_1=n_2=n_m$
P_{max} : per string $< 0.5 * \text{max. recommended PV generator power}$	P_{max} : Per string $< 0.5 * \text{max. recommended PV generator power } P_{max}$ on the MPP tracker used $< \text{max. power per MPP tracker}$	P_{max} : max. recommended PV generator power
MPP tracker A+B together $< \text{max. recommended PV generator power}$		MPP tracker A+B together $< \text{max. recommended PV generator power}$
I_{max} : Amperage per tracker $< \text{max. rated current (DC)}$	I_{max} : $< \text{max. rated current (DC)}$	I_{max} : $\leq 2 * \text{max. rated current (DC)}$

Tab. 3: Electrical data of the connection

7.5.3 Configuring the DC plug connector

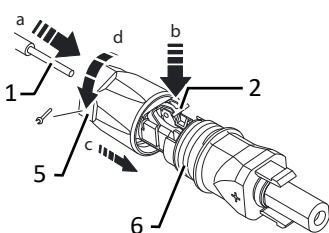

Fig. 21: Insert wires

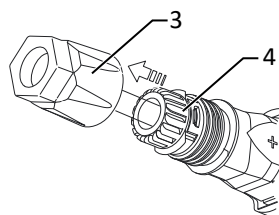

Fig. 22: Slide insert into sleeve

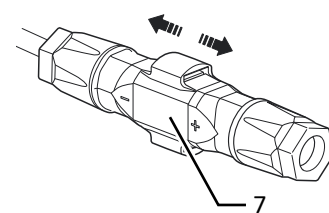



Fig. 23: Check fastening

Key

1	Wire for DC connection	5	Cable fitting
2	Spring	6	Contact plug
3	Insert	7	Coupling
4	Sleeve		

↻ Connection area opened.

↻ **NOTE: Before proceeding with the isolation ensure that you do not cut any individual wires.**

1. Strip the wires for DC connection [s1].
2. Insert isolated wires with twisted ends carefully up to the connection.
 - **NOTE: Wire ends must be visible in the spring.**
3. Close the spring so that the spring latches.
4. Slide insert into sleeve.
5. Secure and tighten the cover on the cable fitting [$\times W_{15}$ /  1.8 Nm]
6. Join insert with contact plug.
7. Check latch by lightly pulling on the coupling.

⇒ Make the electrical connections.



NOTE

The permissible bending radius of at least 4x the cable diameter should be observed during installation. Excessive bending force may negatively impact the protection rating.

1. All mechanical loads must be absorbed in front of the plug connection.
2. Rigid adaptations are not permitted on DC plug connectors.

7.5.4 Designing the PV generator

CAUTION

Damage to components due to faulty configuration

In the expected temperature range of the PV generator, the values for the no-load-voltage and the short circuit current must never exceed the values for $U_{dcm\max}$ and $I_{sc\max}$ in accordance with the technical data.

1. Observe limit values in accordance with the technical data.



NOTE

Type and configuration of the PV modules.

Connected PV modules must be dimensioned for the DC system voltage in accordance with IEC 61730 Class A, but at least for the value of the AC grid voltage



NOTE

Dimensioning the PV generator

The device is designed with a reserve of DC short-circuit current resistance. This enables an overdimensioning of the connected PV generator. The absolute limit for the PV generator is the value of the maximal short circuit current ($I_{SC\max}$) and the maximal open circuit voltage ($U_{oc\max}$). See Footnote under [See section 4.1 ▶ Page 12]

7.5.5 Connecting the PV generator



! DANGER

Risk of fatal injury due to electric shock!

Severe injury or death will result if the live connections are touched. When there is sunlight present on the PV generator, there is DC voltage on the open ends of the DC cables.

1. Only touch the PV generator cables on the insulation. Do not touch the exposed ends of the cables.
2. Avoid short circuits.
3. Do not connect any strings with a ground fault to the device.

! CAUTION

Damage to the PV generator in case of faulty configuration of the DC connector.

A faulty configuration of the DC connector (polarity +/-) causes equipment damage in the DC connection if it is connected permanently.

1. Please check polarity (+/-) of the DC connector before connecting the DC generator.
2. Before using the solar modules, check the vendor's calculated voltage values against those actually measured. The DC voltage of the PV system must not exceed the maximum no-load voltage at any time.

Connecting the PV generator

- PV generator is dimensioned according to the performance characteristics of the unit.
1. Remove protective caps from the required DC connection plugs on the underside of the device.
 2. Connect the DC plug connectors to the DC positive and DC negative connectors in pairs.
- ⇒ The device is connected to the PV generator.

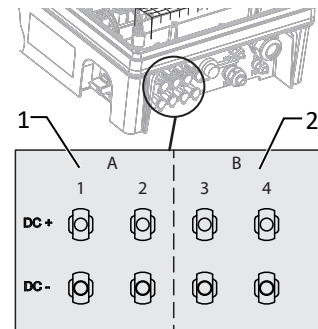

Fig. 24: Connection for DC positive and DC negative

7.6 Inserting the overvoltage protection

Inserting the DC overvoltage protection modules

- **NOTE: A check has been performed to ensure there is no AC/DC voltage present.**
1. [See section 7.1 ▶ Page 21].
 - **NOTE: The coding at the base plug-in position must match the coding on the module.**
 2. Insert the DC overvoltage protection modules into the DC base one after another.
 3. Secure the new modules using the interlock. [~~X~~S_3.5]
 4. Ensure that all protective elements are properly secured.
- ⇒ Move on to connect remote signal monitoring or lock the housing cover. [See section 7.9 ▶ Page 31].

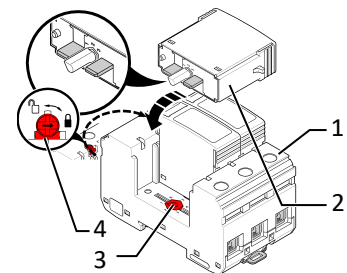

Fig. 25: Inserting the DC overvoltage protection

- 1 DC base
- 2 DC module
- 3 Coding switch
- 4 Lock

Connecting remote signal monitoring

- ⌚ It has been ensured that there is no AC/DC voltage present.
- ⌚ Housing cover open.
- 1. Loosen the cable fitting to pass the signal cable through [XW_20]
- 2. Replace the sealing insert in the cable fitting with a multiple sealing insert.
- 3. Feed the remote signal monitoring signal cable through the cable gland and into the housing.

NOTE: Refer to the technical details on connecting remote signal monitoring!

1. Connect the signal cable to the connection terminal of the DC overvoltage protection in accordance with the terminal allocation [XS_3,5 / \uparrow 0.25 Nm]
 2. Lay the signal cable correctly and tighten the cable fitting [XW_20 / \uparrow 1.5 Nm]
- ⇒ Remote signal monitoring connected. Proceed with the installation of the device.

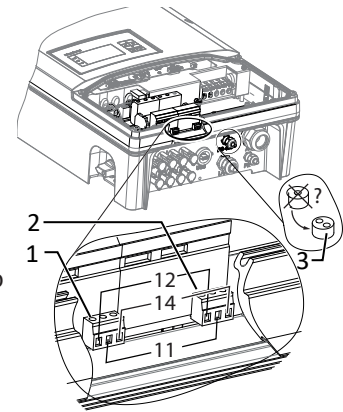

Fig. 26: Connecting overvoltage protection with remote signal monitoring

- 1 Terminal block 1 [11,12,14]
- 3 Terminal block 2 [11,12,14]
- 5 Multiple sealing insert

Technical data for:	Connecting remote signal monitoring
Operating voltage (AC) / operating voltage (DC)	5 - 250 V / 30 V
Operating current (AC ³) / operating current (DC)	5mA – 1.5 A / 1 A
Type of connection	Screw connection
Screw thread	M2
Tightening torque	0.25 Nm
Length of insulation to be stripped off	7 mm
Cable cross-section [flexible / rigid]	0.14 – 1.5 mm ²
Conductor cross-section	28 – 16 AWG
Terminal allocation	11, 12 [normally closed contact] 11, 14 [normally open contact]

7.7 Creating equipotential bonding

- ⌚ The device has been installed on the mount.
 - 1. Undo the cable fitting for housing ground connection [XW_20]
 - 2. Insert the cable for equipotential bonding through the cable fitting provided into the connection area.
 - 3. Strip the insulation from the equipotential bonding cable.
 - 4. Furnish the stripped cable with an M4 ring cable lug.
 - 5. Lay the equipotential bonding cable onto the grounding point and attach with the M4 x 10 bolt and lock washer provided [XW_T30 / \uparrow 2.2 Nm].
 - 6. Check that the connected cable is fitted securely.
 - 7. Tighten the cable fitting for the housing ground connection [XW_20 / \uparrow 1.5 Nm].
- ⇒ The housing is included in the equipotential bonding.

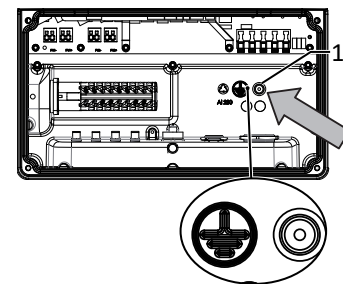

Fig. 27: Earthing point

- 1 Earthing bolt

³ There must be a current of >5mA at all times to act as corrosion protection in order to use the evaluation contact.

7.8 Connecting the interfaces

7.8.1 Overview



! DANGER

Risk of fatal injury due to electric shock!

Severe injury or death may result from improper use of the interface connections and failure to observe protection class III.

1. The SELV circuits (SELV: safety extra low voltage) can only be connected to other SELV circuits with protection class III.

! CAUTION

Damage to the device from electrostatic discharge

Components inside the device can be damaged beyond repair by static discharge.

1. Observe the ESD protective measures.
2. Earth yourself before touching a component by touching a grounded object.



NOTE

Due to the installation position of the communication circuit board, this must be specially safeguarded against moisture and exposure to dust.

1. Make sure that no moisture or dust impacts on the circuit board during installation. Moisture and dust particles must be removed immediately. In doing so, disassembly of the circuit board may be necessary.

All interfaces are located on the communication circuit board (HMI board) inside the housing.

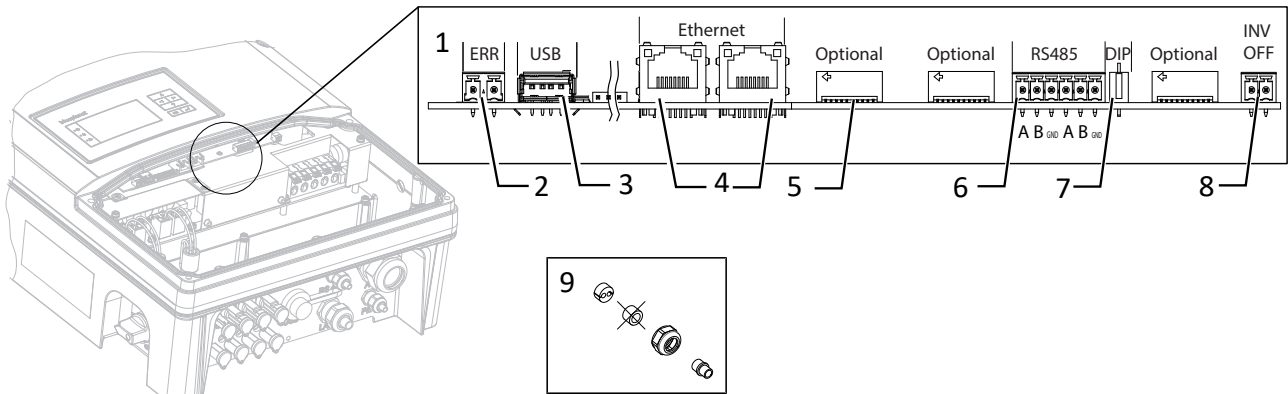

Fig. 28: Communication circuit board (HMI board)

- | | |
|---|--|
| 1 Communication circuit board | 6 RS485 Bus |
| 2 ERR connection for external grid protection component (fault signal relay) | 7 DIP switch for terminal resistance |
| 3 USB socket | 8 INV OFF - connection for remote controls - 24V(+/- 20%) / 1A (at least 15mA) |
| 4 Ethernet port | 9 Multiple sealing insert |
| 5 Optional connection of extension module (e.g. for ripple control receiver, SPI) | |

7.8.2 Insert and lay the cables

1. Observe the instructions on the recommended cable for the interface used.
 2. Open the housing door.
 3. Unfasten the cover on the cable fitting [XW_20].
 4. Feed the signal cable into the connection area.
- ⇒ Signal cable inserted.

Inserting the Ethernet cable

1. Unfasten and remove the cover on the cable fitting [XW_29].
 2. Remove the sealing insert.
 3. Pass the connection cable through the cover of the cable fitting and the sealing insert.
 4. Insert the sealing insert into the cable fitting.
 5. Feed the connection cables into the connection area.
- ⇒ Ethernet cable inserted.

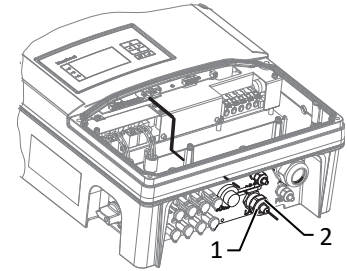

Fig. 29: Inserting the Ethernet cable

- 1 Ethernet cable
- 2 Cable fitting

7.8.3 Ethernet connection



NOTE

The connection plug of an RJ45 cable is larger than the opening of an M25 cable fitting when it is installed. For this reason, remove the sealing insert before installation and thread the Ethernet cable outside of the cable fitting through the sealing insert.



NOTE

Use a suitable category 5 network cable. The maximum length of a network segment is 100 m. Ensure that the cable is correctly assigned. The Ethernet connection of the device supports auto-sensing. You can use both crossed and 1:1 protectively-wired Ethernet connection cables.

⌚ Connecting cable inside the device.

1. Plug in an Ethernet cable at one of the two Ethernet ports on the communication circuit board.
 2. Loosely fasten the connection cable to the door beams using cable ties.
 3. For shielding, strip the Ethernet data cable at the position of the shield clamp up to the wire mesh (approx. 20mm) and fix it with cable ties.
 4. Open and close the door completely to check that the connection cable is not subject to tensile or compressive forces.
 5. Check that the connecting cable is fitted securely.
 6. Tighten the cable fittings [(XW_29 /  4 Nm].
- ⇒ Connect additional signal cables.

Connecting the device to the network

⌚ Connect the Ethernet cable to the device.

1. Connect the Ethernet cable to the network or a computer.
2. Configure the Ethernet settings and the web server in the Settings menu.

7.8.4 Connecting the RS485 Bus



NOTE

Ensure that the DATA+ and DATA- wires are properly connected. Communication is not possible if the wires are reversed! Different manufacturers do not always interpret the standard on which the RS485 protocol is based in the same way. Note that the wire designations (DATA- and DATA+) for wires A and B may vary from one manufacturer to another.

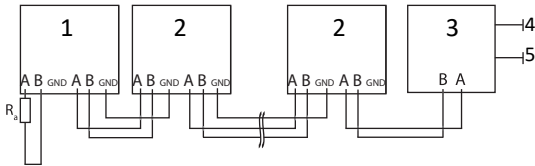



Fig. 30: RS485 interface wiring diagram

1 Inverter, terminal unit	4 Communication
2 Inverter	5 Power supply
3 Data monitoring unit	

Properties of the RS485 data line	
Maximum length of the RS485 bus line	Max. 1200 m This length can be reached only under optimum conditions. Cable lengths exceeding 500 m generally require a repeater or a hub.
Maximum number of connected bus devices	99 devices + 1 data monitoring unit
Data line	Twisted, shielded.
Recommendation	Li2YCYv (twisted pair) black for laying cable outside and in the ground, 2 x 2 x 0.5 mm ² Li2YCY (twisted pair) grey for dry and damp indoor spaces, 2 x 2 x 0.5 mm ²

- To prevent interference during data transmission:
 - Observe the wire pairing when connecting DATA+ and DATA-.
 - Do not lay RS485 bus lines in the vicinity of live DC/AC cables.
- 1. Loosen the cable fitting [~~X~~W_20]
- 2. Thread the connection cables through the cable fitting.
- 3. Open and close the door completely to check that the connection cable is not subject to tensile or compressive forces.
- 4. Connect the connection cable to the corresponding connection terminals.
- 5. The following must be connected to all inverters and to the data monitor unit in the same way:
 - Wire A (-) to wire A (-) and wire B (+) to wire B (+)
 - GND to GND
- 6. Secure cable ties.
- 7. Tighten the cable fittings [~~X~~W_20 /  1.5 Nm]

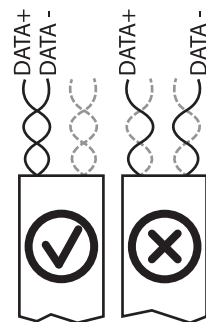



Fig. 31: Assignment of twisted-pair wires



NOTE

When using the RS485 bus system, assign a unique address to every bus device (inverter, sensor) and terminate the terminal units (see the "Settings" menu).

- Check whether one of the devices represents the terminal unit.
-  Only activate the terminating resistor on the communication circuit board of the terminal unit using the DIP switch.

⇒ RS485 connection made. Lay signal cable correctly.

7.8.5 Connecting external grid protection components

The contact is designed as an N/O contact and is labelled "ERR" or "Relay" on the circuit board. [[See section 7.8.1 ▶ Page 28]]

Maximum contact load

DC	30 V / 1 A
AC	250 V / 1 A

⌚ Connection area cover open.

1. Loosen the cable fitting to pass the signal cable through [XW_20]
2. Thread the connection cables through the cable fitting.
3. Attach the connection cables to the terminals.
4. Tighten the cable fitting [XW_20 /  1.5 Nm]

7.8.6 Inverter Off connection



NOTE

The digital input of the device is intended for connection of a Powador-protect. When using devices from other manufacturers or in combination with KACO inverters, interface switches as a minimum must be used for shutting down devices from other manufacturers.

Connect Powador-protect

- ⌚ The cable to the external grid protection device is available on the device.
 - ⌚ Cover of the device has been opened.
1. Undo the cable fittings [XW_20]
 2. Pass the connection cable through the cable fittings.
 3. Connect wire A (+) to the terminal marked "INV OFF+" on the first device via the "DO1" terminal of the protective device.
 4. Connect wire B (-) to the terminal marked "INV OFF-" on the first device via the "GND" terminal of the protective device.
 5. Connect the other devices to one another as follows:
 - wire A (+) to wire A (+) and wire B (-) to wire B (-).
 6. Tighten the cable fitting [XW_20 /  1.5 Nm]
 7. After commissioning: Configure the external Overvoltage protection Powador-protect in the menu entry Properties / Functions Properties / functions.

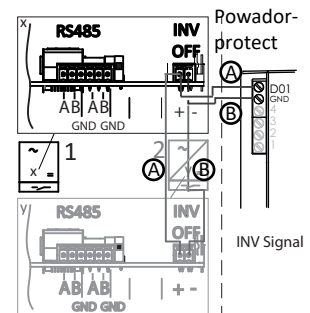



Fig. 32: Connecting the device to Powador-protect

7.9 Sealing the connection area

- ⌚ Grid connection is prepared.
1. Lift the housing cover onto the housing and loosely tighten the fastening screws.
 2. Secure the housing cover by tightening the 4 screws in a diagonally opposite sequence [XT_30 /  10 Nm].
- ⇒ The device has been mounted and installed.
- ⇒ Put the device into operation.

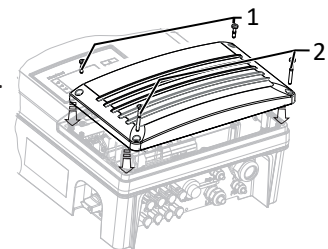

Fig. 33: Closing the housing cover

- 1 Screw [M6x25]
- 2 Screw [M6x55]

8 Commissioning

8.1 Requirements



⚠ DANGER

Lethal voltages are still present in the connections and cables of the device even after the device has been switched off and disconnected!

Severe injuries or death may occur if the cables and/or terminals/busbars in the device are touched.

1. The device is only permitted to be commissioned by a qualified professional.
2. Unauthorised persons must be kept away from the device.

- ⊖ The device has been mounted and electrically installed.
- ⊖ The PV generator supplies a voltage above the configured start voltage.
 1. Connect the grid voltage using the external circuit breakers.
 2. Connect the PV generator using the DC isolator switch (0 > 1)
- ⇒ The device begins operation.
- ⇒ During initial start-up: Follow the instructions of the New Connection Wizard.

8.2 Preconditions relating to standards

Attachment of safety label in accordance with UTE C15-712-1

The code of practice UTE C15-712-1 requires that, upon connection to the French low-voltage distribution network, a safety sticker showing a warning to isolate both power sources when working on the device must be attached to each device.

- ☞ Attach the provided safety sticker to the outside of the device housing where it is clearly visible.

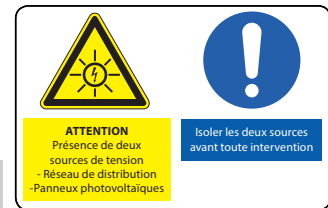

Fig. 34: Safety label UTE C15-712-1

9 Configuration and operation

9.1 Initial start-up

When started for the first time, the device displays the configuration assistant. It takes you through the settings necessary for the initial start-up.



NOTE

After configuration is completed, the configuration assistant does not appear again when the device is restarted. You can then change the country setting only in the password-protected parameter menu. The other settings can still be changed in the Settings menu.

1. In order to select a setting, press the **Up** and **Down** buttons.
2. To select the next menu option, press the **Enter** button.
3. To return to the most recently selected menu option, press the **ESC** button.
4. Set the required settings.
5. In the last menu option, press the **Enter** button.















Configuration assistant

1. Select the menu language.
 2. Select the country of operation with grid type.
 3. Set the date and time.
 4. To store the set operator country and grid type permanently, confirm with "Yes".
- ⇒ You have completed the initial configuration. The device begins operation.









9.2 Controls

The device has a backlit LCD display as well as three status LEDs. The device is operated using 6 buttons.

The 3 LEDs on the device control panel show the different operating states. The LEDs can display the following states:

Operating status	LED	Icon	Display	Description
Start	 LED illuminated	 LED flashing	 LED not illuminated	
Start				The green "Operation" LED is on when the AC voltage is present, independent of the DC voltage.
Feed-in start			Power fed into the grid or measured values	The green "Operating" LED is lit.
				The green "Feed-in" LED is lit after the country-specific waiting period ⁴ . Ready for grid operation. The interface switch engages audibly.
Feed-in operation			Power fed into the grid or measured values	The green "Operating" LED is lit.
				The green "Feed-in" LED is lit. The "Feed-in" icon appears on the LD display. The device feeds into the grid.
Feed-in mode with reduced power			Power fed into the grid or measured values	The green "Operating" LED is lit.

⁴ *) The waiting period ensures that the generator voltage continuously remains above the power delivery limit of 200 V. For country-specific waiting periods see our website.

Operating status	LED	Icon	Display	Description
				The green LED "Feed" is flashing because one of the modes: internal power reduction, external power reduction, idle power request or standalone mode is active. The device feeds into the grid. The interface switch engages audibly.
Non-grid feed mode	 	 	Status message	The display shows the corresponding message.
Error			Fault message	The display shows the corresponding error message. The red "Fault" LED is lit.

Control buttons

The device is operated using the 4-way button and the Enter and ESC buttons.

Opening the menu

⌚ The device is in operation and the LCD is showing the desktop.

☞ Press the `right arrow` button.

⇒ The menu moves over the desktop from left to right.

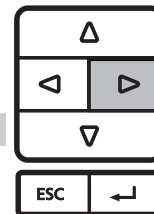

Displaying the daily output

⌚ The device is in operation and the LCD is showing the desktop.

☞ Press the `down arrow` button.

⇒ The LCD displays the daily yield in a diagram.

☞ To return to the desktop, press any button.

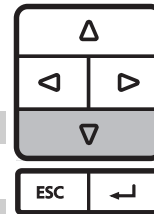

Device menu

Selecting a menu option

⌚ You have left the desktop. The device displays the menu.

☞ Use the `up` button or `down` button to navigate.

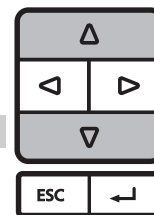

Opening a menu item or a setting

☞ Use the `right arrow` button and the `Enter` button.

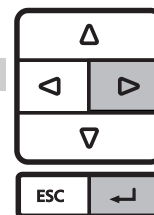

Navigate to the next higher menu level/discard change

☞ Use the left arrow button or the ESC button.

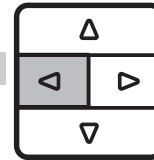

Selecting an option

☞ Use the right and left arrow buttons.

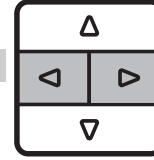

Changing an option/the value of an input field

☞ Use the up and down arrow buttons.

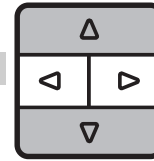

Saving changed setting

☞ Press the Enter button.

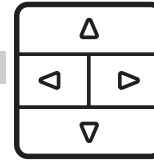

9.3 User interface

After being switched on and after initial commissioning is complete, the device displays the start screen (the desktop). If you are in the menu and do not touch any control buttons for 2 minutes, the device returns to the start screen.

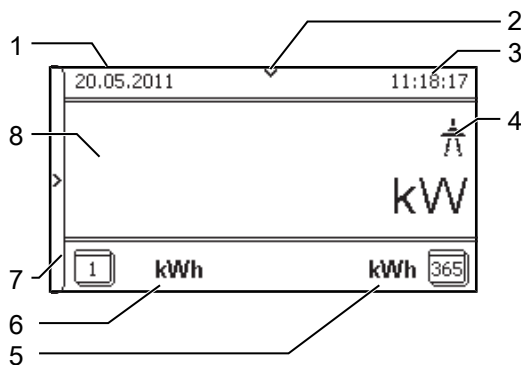

Fig. 35: Desktop

1 Current date	5 Annual yield
2 Status bar	6 Daily yield
3 Current time	7 Menu indicator
4 Feed-in indicator	8 Current power

Graphical display

The graphical display shows measured values and data and allows the configuration of the device using a graphical menu. In normal operation, the backlighting is switched off. As soon as you press one of the control buttons, the backlighting is activated. If no button is pressed for an adjustable period of time, the backlighting switches off again. You can also activate or disable the backlighting permanently.



NOTE

Depending on the tolerances of the measuring elements, the measured and displayed values are not always the actual values. However, the measuring elements ensure maximum solar yield. Due to these tolerances, the daily yields shown on the display/Monitor may deviate from the values on the grid operator's feed-in meter by up to 15%.



NOTE

Calculating efficiency by measuring the current and voltage values can lead to misleading results due to the tolerances of the measurement devices. The purpose of these measured values is to monitor the basic operation of the system.

9.4 Menu structure

Display on the LCD

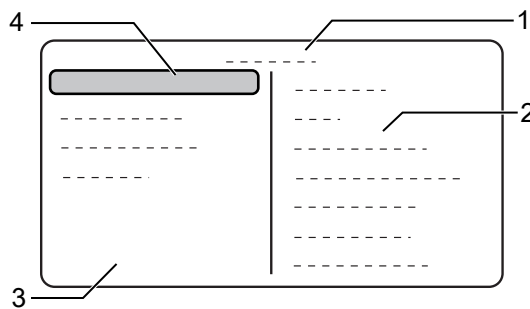

Fig. 36: Main menu







- 1 Selected menu option
- 2 Name of the active menu level
- 3 Menu options in the active menu level
- 4 Menu options of the next lower menu level











NOTE

























The menu options displayed on screen are dependent on the country and network settings, and may vary according to the type of device. Functions restricted to one or more countries are labelled with country codes in accordance with ISO 3166-1.















Symbols used

	Menu level (0,1,2,3)		Password-protected menu (password can be requested from KACO customer service)
	Display		Submenu
	Option menu		Option box
			Setting range























9.4.1 Menu







Country-spec. Settings	Menu level	Display/Setting	Action in this menu/meaning
	 Desktop		 Press Right arrow button.
	 Measured values		 Open the menu: Press the right arrow button or the OK button.
	 Generator		Displays the DC-side voltage, amperage and power.
	 Grid		Displays the AC-side voltage, amperage and power.







Country-spec. Settings	Menu Setting level	Display/Setting	Action in this menu/meaning
	1-3-3-4	Power control	 Displays the current value of the external power limitation by the grid operator.
	3-3-3-4	cos-phi	 Displays the reactive power factor $\cos \varphi$ of the node.
	1-3-3-4	Unit temperature	 Displays the temperature inside the housing.
	1-3-3-4	Yield counter	 Displays the yield in kWh.  Reset the counter using the <code>RESET</code> button.
	1-3-3-4	Yield today	 Displays the cumulative yield for the current day.
	1-3-3-4	Total yield	 Displays the total yield up to now.
	1-3-3-4	CO2 savings	 Displays the calculated CO ₂ savings (in kg).
	1-3-3-4	Oper. hrs cntnr	 NOTE: Displays the operating time in hours.  Reset the counter using the <code>RESET</code> button.
	1-3-3-4	Oper. time today	 Displays the duration of operation on today's date.
	1-3-3-4	Total oper. time	 Displays the total operating time
	1-3-3-4	Log data display	 NOTE: Measurement data can be transferred hierarchically to a connected USB stick by individual selection.  Open the menu: Press the <code>Right arrow</code> button or <code>Enter</code> button.
	1-3-3-4	Day display	 NOTE: Displays the recorded operating data graphically.  Select the measured value to be displayed. Supported measured values: 1. Grid power P(grid) 2. DC power of the string P 3. DC voltage of the string U 1. Select a day. 2. Press the <code>Enter</code> button. ⇒ The display shows the selected data. 3. Press any button to return to the previous menu.
	3-3-3-4	Month display	 Displays the recorded operating data graphically.  1. Select a month. 2. Press the <code>Enter</code> button. ⇒ The display shows the selected data.  Press any button to return to the previous menu.
	3-3-3-4	Year display	 Displays the recorded operating data graphically.  1. Select a year. 2. Press the <code>Enter</code> button. ⇒ The display shows the selected data. ⇒ Press any button to return to the previous menu.
	3-3-3-4	CSV log data	  Open the menu: Press the <code>Right arrow</code> button or <code>Enter</code> button.
	3-3-3-4	Decimal separator	  Select decimal sign for export of saved operating data.







Country-spec. Settings	Menu level	Display/Setting	Action in this menu/meaning
	☐☐☐☐	Save to USB	 NOTE: Opportunity to export the operating data to a connected USB storage device. <ul style="list-style-type: none"> ↻ You have connected a USB storage device to the device. 1. Select the data to be exported (year, month or day). 2. Press the <code>Enter</code> button. ⇒ The device writes the data to a connected USB storage device.
	☐☐☐☐	Settings	 <ul style="list-style-type: none"> ☞ Open the menu: Press the <code>Right arrow</code> button or <code>Enter</code> button.
	1-☐☐☐☐	Language	 <ul style="list-style-type: none"> ☞ Select the required language for the user interface.
	1-☐☐☐☐	Def. total yield	 NOTE: You can set the total yield to any value, for example, when you have received a replacement device and want to continue the recording from the present value. <ul style="list-style-type: none"> ☞ Select the <code>Save</code> button and confirm with the <code>Enter</code> button.
	1-☐☐☐☐	Interface	 NOTE: The address must not be the same as the address of another device or a Powador-proLOG device. <ul style="list-style-type: none"> ☞ Assign a unique RS485 bus address to the device.
	1-☐☐☐☐	Priwatt	 <ul style="list-style-type: none"> ☞ Open the menu: Press the <code>Right arrow</code> button or <code>Enter</code> button.
	☐☐☐☐	Activation mode	 NOTE: Re-activation depends on the operating mode selected and on the activation conditions. <ul style="list-style-type: none"> ☞ Activate function for a cycle
	☐☐☐☐	Monitoring time	 <ul style="list-style-type: none"> ☞ Set time span during which the power threshold must be exceeded without interruption.
	☐☐☐☐	Power threshold	 <ul style="list-style-type: none"> ☞ Set power threshold from which the monitoring time up to activation begins.
	☐☐☐☐	Operation mode	 <ol style="list-style-type: none"> 1. Power-dependent: the function remains active until below the set power threshold. 2. Time-dependent: The function is active independent of the sunlight for the set operation time.
	☐☐☐☐	Operation time	 NOTE: The menu option is only available in "Time-dependent" operation mode. <ul style="list-style-type: none"> ☞ After connection, the function is active for the set operation time.
	1-☐☐☐☐	Quick start	 <ul style="list-style-type: none"> ☞ Reduce the waiting times during the self-test by pressing the <code>Activate</code> button.
	1-☐☐☐☐	Logging interval	 <ul style="list-style-type: none"> ☞ Specify the time period between 2 log data recordings.
	1-☐☐☐☐	Log data backup	 NOTE: The device supports the backing up of all recorded yield data to a connected USB storage device. <ul style="list-style-type: none"> ☞ Activate or deactivate log data backup
	1-☐☐☐☐	Display	 <ol style="list-style-type: none"> 1. Configure the contrast setting for the display. 2. Set the length of time without user input after which the backlighting of the LCD switches off. 3. Alternatively: Permanently activate or disable the backlighting by selecting "On" or "Off".

















Country-spec. Settings	Menu level	Display/Setting	Action in this menu/meaning
	1-2-3-4	Date & time	<p>NOTE: For self-diagnostics, the device performs a restart on a daily basis at 0:00 hours. To avoid having a restart occur during feed-in operation and to always obtain reliable log data, ensure that the time is correctly set.</p> <p>☞ Set the date and time.</p>
	1-2-3-4	Network	<p>☞ Open the menu: Press the Right arrow button or Enter button.</p>
	1-2-3-4	DHCP ☑ On / Off	<p>NOTE: The "IP address", "Subnet mask", "Gateway" and "DNS-Server" menu options are only displayed with DHCP disabled.</p> <p>☞ Activate or deactivate DHCP.</p> <p>On: Once the DHCP server becomes available, the IP address, subnet mask, gateway and DNS server are automatically applied and the aforementioned menu options are hidden.</p> <p>Off: Apply settings manually.</p>
	1-2-3-4	IP address	☞ Allocate a unique IPv4 address in the network.
	1-2-3-4	IP address	<p>NOTE: The "IP address", "Subnet masks", "Gateway" and "DNS server" menu items are only displayed with DHCP disabled.</p>
	1-2-3-4	Subnet mask	☞ Assign a subnet mask.
	1-2-3-4	Gateway	☞ Enter IPv4 address of the gateway.
	1-2-3-4	DNS server	☞ Enter IPv4 address of DNS server.
	1-2-3-4	Web server	☞ Open the menu: Press the Right arrow button or Enter button.
	1-2-3-4	Operation mode	☞ Activate or disable the integrated web server.
	1-2-3-4	Port	☞ Set the port at which the web server can be reached.
	1-2-3-4	Remote config ☑ On / Off	☞ If necessary, activate the remote configuration.
	1-2-3-4	Remote update ☑ On / Off	☞ If necessary, activate the remote update.
	1-2-3-4	Portal Connection test ☑ Off Meteocontrol User-defined 1-4:	<p>🔄 Your IT infrastructure must be adequately protected.</p> <p>☞ Select operating mode.</p> <p>Off: The connection to the portal is deactivated.</p> <p>Meteocontrol: The device attempts to connect to the Webportal blueplanet web of meteocontrol.</p> <p>User defined 1-4: The device attempts to log on via a user-defined portal that was set up by way of remote access.</p>
	1-2-3-4	Modbus TCP	☞ Activate/disable function.
	1-2-3-4	Activation	<p>NOTE: The menu options "Write access" and "Port" are only displayed with TCP activated.</p> <p>1. Activate Modbus TCP.</p>
	1-2-3-4	Write access	☞ Allow Modbus TCP write access.
	1-2-3-4	Port	☞ Set network port.
	1-2-3-4	Connection status	👁 Indicates the status of the network connection.













Country-spec. Settings	Menu	Display/Setting level	Action in this menu/meaning
		Parameters	<p> Press the Right arrow button or Enter button.</p> <p>NOTE: The device does not display the "Parameters" menu in the standard configuration. To display the Parameters menu:</p> <ol style="list-style-type: none"> 1. Open the menu. 2. Simultaneously hold down the Up and Down buttons for several seconds.
		Password protection	<p> NOTE: Opportunity to set password protection.</p> <p>Selecting "yes" initiates a password request for the entire menu item: Parameters.</p>
		Status On/Off	
		Country	<p> NOTE: This option influences the country-specific operating settings of the device. Please consult KACO service for further information.</p> <p></p> <ol style="list-style-type: none"> 1. Enter the four-digit password using the 4-way button. The password is device-specific. 2. Confirm the entry with the Enter button. 3. Set the desired country setting.
CH, DE, ES, FR, GB, GR, IT, JO, JP, LU, TH, ZA		Grid type/guideline	<p> Select the grid type for the device's installation location.</p>
UD		Nominal grid voltage	<p> Set the specified grid voltage for the site where the device is used (please contact KACO Service)</p>
		Grid parameter	<p> Open the menu: Press the Right arrow button or Enter button.</p>
AT, BG, CZ, FR-OLD, FR-VFR13, FR-VFR14, IE, JP, NL, PL, PT, TR, TW, UD		Overvoltage shutd. 10 min. mean value	<p> 1. Specify the shutdown threshold for overvoltage trip-off.</p> <p>⇒ The 10-minute average for the measured voltage as per EN50160 is used.</p> <p> 2. Set period from occurrence of the fault to shutdown of the device.</p>
BE CH-NS CY DE-NS DK LU-NS		Overvoltage shutd. 10 min. mean value Password protection	<p> 1. Activate or disable password protection.</p> <p> 2. Specify the shutdown threshold for overvoltage trip-off.</p> <p>⇒ The 10-minute average for the measured voltage as per EN50160 is used.</p> <p>3. Set period from occurrence of the fault to shutdown of the device.</p>
AT FR-OLD FR-VFR13 FR-VFR14 JP-50HZ JP-60HZ UD		Voltage drop	<p> NOTE: The voltage drop between the device and the feed-in meter is added to the limit value that was set for grid shutdown according to EN 50160. The limit value can be set to 0-11 Volt increments.</p> <p> Specify the shutdown value for the voltage drop (0-11 Volt).</p>











Country-spec. Settings	Menu Setting level	Display/Setting	Action in this menu/meaning
BE CH-NS CY DE-NS DK LU-NS	1-3-3-3	Switch-off volt.	 NOTE: The device is equipped with redundant 3-phase monitoring. If the grid voltage exceeds or drops below the configured values, the device switches off. The minimum switch-off threshold can be set in 1 Volt increments. <ol style="list-style-type: none"> 1. Configure the switch-off values for undervoltage and overvoltage. 2. Where applicable, set period from occurrence of the fault to shutdown of the device.
AT, AU, BG, CH—MS, CZ, DE-MS, ES, FR, GB, GR, HR, HU, IE, IL, IN, IT, JO, JP, KR, NL, PL, PT, RO, TH, TR, TW, DU, ZA	1-3-3-3	Overvoltage shutd.	 <ol style="list-style-type: none"> 1. Specify the shutdown threshold for fast and slow overvoltage shutdown. 2. Set period from occurrence of the fault to shutdown of the device.
See Over-voltage shutd.	1-3-3-3	Undervoltage shutd.	 <ol style="list-style-type: none"> 1. Specify the shutdown thresholds for fast and slow overvoltage shutdown. 2. Set period from occurrence of the fault to shutdown of the device.
AT, AU, BG, CD-MS, CZ, DE-MS, ES, FR, GB, GR, HR, HU, IE, IL, IN, IT, JO, JP, KR, NL, PL, PT, RO, TH, TR, TW, DU, ZA	1-3-3-3	Overfreq. shutd.	  Set limit value for the slow and fast overfrequency shutdown.
▶ Page 000]	1-3-3-3	Underfreq. shutd.	  Set limit value for the slow and fast underfrequency shutdown.





Country-spec. Settings	Menu	Display/Setting level	Action in this menu/meaning
	Grid parameter (further information)		 <p>If the value U< (slow undervoltage shutdown) is set to a value which is greater than the value of U_{con, min} (minimum restart voltage) using the LC display, then the value of U_{con, min} is automatically set to the value of U>.</p> <p>If the value U> (slow overvoltage shutdown) is set to a value which is smaller than the value of U_{con, max} (maximum restart voltage) using the LC display, then the value of U_{con, max} is automatically set to the value of U>.</p> <p>If the value f< (slow underfrequency shutdown) is set to a value which is greater than the value of f_{con, min} (minimum restart frequency) using the LC display, then the value of f_{con, min} is automatically set to the value of f<.</p> <p>If the value f> (slow overfrequency shutdown) is set to a value which is smaller than the value of f_{con, max} (maximum restart frequency) using the LC display, then the value of f_{con, max} is automatically set to the value of f>.</p>
BE CH-NS CY DE-NS DK LU-NS	Switch-off freq.		<p>NOTE: The device continuously monitors the grid frequency. If the grid voltage exceeds or drops below the configured values, the device switches off.</p> <ol style="list-style-type: none"> Set limit values for underfrequency and overfrequency in 0.1 Hz increments. Set period from occurrence of the fault to shutdown of the device.
	Exten. Parameters		<p>Further parameterisation is possible via the WEBGUI.</p>
	DC starting volt.		<p>The device begins feed-in as soon as this DC voltage is present.</p> <p>Set the starting voltage.</p>
	DC connection		<p>Select between automatic detection and manual setting.</p> <p>NOTE: Note the connection examples!</p> <p>[See section 7.5.2 Page 24]</p>
	Const.volt.reg.		<p>NOTE: Option to disable the MPP seek mode in order to operate the device with a constant DC voltage.</p> <ol style="list-style-type: none"> Activate or disable the constant voltage controller. Set value for constant voltage controller.

Country-spec. Settings	Menu	Display/Setting level	Action in this menu/meaning
		Power limitation.	<p>NOTE: The output power of the device can be set permanently to a lower value than the maximum output power by the power limitation. This may be necessary in order to limit the maximum power rating of the system at the grid connection point, upon the grid operator's request.</p> <p>NOTE: The value can be protected from the very first power limitation entry. After setting a limitation, the value can only be changed by entering a device-specific password.</p> <p>NOTE: Only the external power limitation can be adjusted on the device. The internal power limitation can only be set via the web interface.</p> <p>[See section 9.4.2 Page 47]</p>
		Power limitation. external	<p>NOTE: External power limitation is possible with the extension module (KACO accessories).</p> <ol style="list-style-type: none"> Specify the activation status (on / off). Select the activation threshold (Active Low / Active High) from digital input 1, 2, 3 or 4 (only if activation status = on). Specify the power limitation stages (only if activation status = on) a.) Specify stage 0-3 b.) Specify stage 4-7 c.) Specify stage 8-11 d.) Specify stage 12-15 Confirm the entry with the <code>Enter</code> button.
		Exten. Parameters	<p>Further parameterisation is possible via the WEBGUI.</p>
		Powador-protect ☰ Auto On Off	<p>NOTE: Configures the support for grid shutdown via a Powador protect connected to the „INV OFF“ input of the device.</p> <p>↻ Auto/On: A Powador-protect is operating in the photovoltaic system and is connected to the device at the „INV OFF“ input.</p> <p>☞ Set the operating mode for Powador-protect.</p> <p>Auto: The device automatically detects a Powador-protect integrated into the photovoltaic system.</p> <p>On: The digital signal of the Powador-protect must be present at the digital input of the device for the device to begin feed-in.</p> <p>Off: The device does not check whether a Powador-protect is integrated into the PV system.</p>
		Iso.resistance	<p>☞ Set threshold value (in 1kOhm increments) at which the insulation monitor reports a fault.</p>
		Power reduction P(f)	<p>NOTE: The unit supports the internal power factor correction after P(f).</p> <ol style="list-style-type: none"> Open the menu: Press the <code>Right arrow</code> button or <code>Enter</code> button. <p>☞ Note: All the parameters are configurable here and via the WEB interface NOTE: . [See section 9.4.2 Page 47]</p>
Not for IL, IT		P(f) operation mode ☰ Off Mode 1 Mode 2	<p>NOTE: More detailed information can be found in</p> <p>☞ Specify the operation mode.</p>

Country-spec. Settings	Menu level	Display/Setting	Action in this menu/meaning
	☐☐☐☐	Threshold activated 45 Hz – 70 Hz	 Specify activation threshold (if mode 1 or mode 2 is active, this menu option is displayed permanently for IT and IL!) NOTE: The function is activated if the activation threshold is exceeded. In mode 2 this value also serves as a deactivation threshold.
	☐☐☐☐	Threshold deactivated Min. 45 Hz – 61,5 Hz Max. 45 Hz – 70 Hz	 NOTE: If the grid frequency is within the deactivation range for the duration of the deactivation time, then the function is deactivated. 1. Specify deactivation threshold (if mode 1 or mode 2 is active, this menu option is displayed permanently for IT and IL!).
Not for IL, IT	☐☐☐☐	Deactivation time	 Specify time for power reduction (if mode 1 is active)
	☐☐☐☐	Gradient	 Set gradient of power limitation function with increasing frequency in % / Hz. The percentage value is based on the rated frequency (if mode 1 or mode 2 is active, this menu option is displayed permanently for IT and IL!)
	☐☐☐☐	Intentional delay	 Set the power limitation delay in seconds (if mode 1 or mode 2 is active; this menu option is displayed permanently for IT and IL!).
	☐☐☐☐	Settling time	 Set the power reduction delay in seconds (if mode 1 or mode 2 is active; this menu option is displayed permanently for IT and IL!).
	☐☐☐☐	Rise Outg. grad. & Fall. Outg. grad.	 Specify output gradient increase and decrease in ‰ (per thousand).
	☐☐☐☐	Deact. grad.	 Specify deactivation gradient in ‰ (per thousand) /minute (if mode "1" or mode "2" is active. This menu option is displayed permanently for IT and IL!).
	☐☐☐☐	Fault ride-through	 NOTE: The device supports dynamic grid stabilization (Fault Ride-Through).  Further parameterisation is possible via the web interface
	☐☐☐☐	Reactive power	 <ol style="list-style-type: none"> Open the menu: Press the Right arrow button or Enter button. Activating reactive power process: Select process a press the Enter button. The active process is highlighted.
	☐☐☐☐	cos-phi const. 1- 0.3	 More detailed information about the procedure can be found at: <ol style="list-style-type: none"> [See section 10.1 Page 57] Determine the specified displacement factor.
		Over-excited under-excited	 If a power factor not equal to 1 is selected: Select the type of phase shift: under-excited (inductive load), over-excited (capacitive load).
	☐☐☐☐	Q constant 0 – 100%	 More detailed information about the procedure can be found at: [See section 10.1 Page 57]  Set the idle power Q (in %) to a fixed value.
		Under-excited over-excited	 Select the type of phase shift. NOTE: Under-excited relates to inductive load, over-excited relates to capacitive load.

Country-spec. Settings	Menu Setting level	Display/Setting	Action in this menu/meaning
		 cos-phi(P/Plim)	<p>NOTE: More detailed information about the procedure can be found at: [See section 10.1 ▶ Page 57]</p> <p>☞ Open the menu: Press the Right arrow button or Enter button.</p>
		 Settling time 1s – 120 s	☞ Set the settling time in the event of an abrupt change in the reactive power target value (e.g. caused by a voltage jump). The transient response corresponds to a first-order filter (PT-1) with settling time = 5Tau.
		 Lock-in voltage 23V – 287V	☞ Set the voltage above which control is activated.
		 Lock-out voltage 23V – 287V	☞ Set the voltage below which control is deactivated.
		 Number of nodes 2 - 10	<p>NOTE: The maximum number of configurable nodes depends on the selected grid type.</p> <p>☞ Specify the number of nodes for the $\cos \varphi / (p/pn)$.</p>
		 1st node ... 10th node <input checked="" type="checkbox"/> Voltage <input type="checkbox"/> Reactive power <input type="checkbox"/> Excitation 0-100% 1 – 0.3 Over-excited under-excited	<p>☞ Power factor for 1st ,10th ... node as a percentage of the maximum power.</p> <p>☞ Specify the NOTE: $\cos \phi$ of the node.</p> <p>☞ If a reactive power not equal to 1 is selected: Select the type of phase shift.</p>
		 Q(U) 10 nodes	<p>☞ Open the menu: Press the Right arrow button or Enter button.</p> <p>NOTE: More detailed information about the procedure can be found at: [See section 10.1 ▶ Page 57]</p>
		 Settling time 1s – 120 s	☞ Set the settling time in the event of an abrupt change in the reactive power target value (e.g. caused by a voltage jump). The transient response corresponds to a first-order filter (PT-1) with settling time = 5Tau.
		 Lock-in power 0 – 100% S_{max}	☞ Set the active power as % of rated power above which control is activated.
		 Lock-out power 0-100% S_{max}	☞ Set the active power as % of rated power below which control is deactivated.
		 Lock-in time 0 s – 60 s	☞ Set the length of time that the active power must remain below the lock-in power level before control is activated.
		 Lock-out time 0 s – 60 s	☞ Set the length of time that the active power must remain below the lock-out power level before control is deactivated.
		 Downtime 0-10000 [ms]	If the voltage switches from a characteristic curve section with Q=0 to a characteristic curve section with Q≠0 under active control, then the reactive power setting process is delayed by the set dead time. Once the dead time has expired, the control circuit is no longer subject to a delay and the set transient time determines the transient behaviour.

Country-spec. Settings	Menu level	Display/Setting	Action in this menu/meaning
	☐☐☐☐	Rise Outg. grad. & Fall. Outg. grad. ☐☐☐ increasing decreasing ⚡ 1 %-60000 %/min ⚡ 1 %-60000 %/min	 ⚡ Maximum change in the reactive power %S _{lim} /min in the event of a change to over-excited mode. ⚡ Maximum change in the reactive power %S _{lim} /min in the event of a change to under-excited mode.
	☐☐☐☐	Min. cos-phi Q1 - Min. cos-phi Q4	 NOTE: In the event of a significant voltage deviation, the maximum reactive power adjustment range can be limited by a minimum cos φ in order to prevent an excessive reactive power supply and, as a result, a significant reduction in the maximum active power that can be fed in. ⚡ Enter the minimum cos φ factor for quadrants 1 and 4.
	☐☐☐☐	Priority mode ⚡ Q priority P priority	 ⚡ Set priority for reactive power – Q or active power – P. NOTE: When it comes to P priority, the reactive power adjustment range is limited subject to the active power that is currently available and fed in.
	☐☐☐☐	Active curve ⚡ 1 - 4	 ⚡ Select active curve. NOTE: Up to 4 characteristic curves can be configured independently and one of them can be activated for regulation each time.
	☐☐☐☐	Reset the curve	 ⚡ Reset active curve to the default setting.
	☐☐☐☐	Number of nodes ⚡ 2 - 10	 NOTE: The maximum number of configurable nodes depends on the selected grid type. ⚡ Specify the number of nodes for the Q(U) characteristic curve.
	☐☐☐☐	1st node ... 10th node ☐☐☐ Voltage Reactive power Excitation ⚡ 0 - max. voltage in continuous operation ⚡ 0-100% [% S _{max}] ⚡ Over-excited under-excited	 ⚡ Enter the voltage of the node in volts. ⚡ Set the reactive power of the node as a percentage of the maximum power. ⚡ If a reactive power not equal to 1 is selected: Select the type of phase shift.
	☐☐☐☐	Exten. standalone grid	 NOTE: Grid operators require shutdown of the device with standalone grid detection. ⚡ Further parameterisation is possible via the web interface.
BE CH-NS CY DE-NS DK JP-50HZ JP-60HZ LU-NS TW UD	☐☐☐☐	Line error	 NOTE: Display of grid faults. ⚡ To show the last 5 grid fault messages, press the Show button.
	☐☐☐☐	Advanced features	 ⚡ Further parameterisation is possible via the web interface
	☐☐☐☐	Information	 Open the menu: Press the right arrow button or the OK button.







Country-spec. Settings	Menu Setting level	Display/Setting	Action in this menu/meaning
	1-3-3-4	Inv. type	 Displays the type designation of the device. If feed-in power is actively limited: display maximum power in kW.
	1-3-3-4	SW version	 Displays the installed software version.
	1-3-3-4	Serial number	 Displays the serial number of the device.
	1-3-3-4	Select country	 Displays the selected country setting. Optional: Displays the grid type if a grid type has been selected.
	1-3-3-4	Vendor	 The display shows information about the device manufacturer.

















































9.4.2 Configuration via web user interface



































































NOTE

In addition to the parameters in the chapter [See section 9.4.1 ▶ Page 36], additional parameters are available and accessible via the web user interface. To do so, enable `Remote config` in `Network` under `Web-server` and enter the device IP address into your browser.









































1-3-3-4	Operating settings		NOTE: Options for advanced setting of the operating parameters.
1-3-3-4	DC starting volt.		The device begins feed-in as soon as this DC voltage is present. ☞ Set the starting voltage.
1-3-3-4	Const.volt.reg.		NOTE: Option to disable the MPP seek mode in order to operate the device with a constant DC voltage. 1. Activate or disable the constant voltage controller. 2. Set value for constant voltage controller.
1-3-3-4	Iso.resistance		☞ Set threshold value (in 1kOhm increments) at which the insulation monitor reports a fault.
1-3-3-4	3-phase monitoring ☑ On / Off		NOTE: The device is equipped with redundant 3-phase monitoring. If the grid voltage exceeds or drops below the configured values, the device switches off. The minimum switch-off threshold can be set in 1 V increments. ☞ Activate or disable monitoring.
1-3-3-4	FRT (Fault Ride Through)		NOTE: The device supports dynamic grid stabilization (Fault Ride-Through).NOTE: More detailed information at: [See section 10.3 ▶ Page 65]
1-3-3-4	☑ Operation mode – On Off		☞ Select a control process. On: Activates dynamic grid support using dynamic reactive current. Off: Deactivates dynamic grid support using dynamic reactive current. Dynamic grid support remains active on account of immunity to interference.
	Settings Manual Pre-defined zero current		☞ Select a control process.
	Priority – Reactive current limitation Dynamic reactive current		☞ Select a control process.

<p> Constant K positive sequence dip & Constant K positive sequence swell</p> <p> k 0 – 10  2</p>		<p> Set amplification factor k for the pos. sequence for drop and increase in the grid voltage.</p>
<p> Constant K negative sequence dip</p> <p>Constant K negative sequence swell</p> <p> k 0 – 10  2</p>		<p> Set amplification factor k for the neg. sequence for drop and increase in the grid voltage.</p>
<p> Dead band</p> <p> 0 - 100 [% Uref]  10.0</p>		<p> Set dead band in %.</p>
<p> Dynamic reactive current only</p> <p> Off On</p>		<p>NOTE: With FRT mode activated, the pre-fault reactive current can be added.</p> <p> If necessary, activate pre-fault reactive current.</p>
<p> Dead band mode</p> <p> Mode 1 Mode 2</p>		<p> Select dead band mode for the active control process.</p>
<p> Reference voltage</p> <p> U< - U></p>		<p> Set reference voltage for the active control process.</p>
<p> Minimum operating voltage</p> <p> 45 – 125.0 [% Unom]</p> <p>&</p> <p>Maximum operating voltage</p> <p> 45 – xxx [% Unom]</p> <p>Password protection</p> <p> Status</p>		<p> Set voltage range for the active control process.</p>
<p> Zero current under-voltage threshold</p> <p>Zero current over-voltage threshold</p> <p> 0 – 184 V / 253 – 340 V</p>		<p> Set the voltage threshold for zero current mode.</p>
<p> Reactive current limitation</p> <p> 0 – 100 % [% Imax]</p>		<p> Set the reactive power limitation.</p>
<p> Minimum support time</p> <p> 1000 – 15000 ms</p>		<p> Set the minimum support time.</p>
<p> Connection cond.</p>	 	<p>NOTE: The device checks the grid voltage and grid frequency. The grid feed-in mode begins if the measurements are within the set ranges.</p> <p> Set minimum and maximum values for connection.</p>

<p> Min. switch-on voltage after grid monitoring</p> <p>Max. switch-on voltage after grid monitoring</p> <p> 207 [V] - 253 [V]</p>		<p> Set min. and max. switch-on voltage after grid monitoring.</p>
<p> Min. switch-on frequency after grid monitoring</p> <p>Max. switch-on frequency after grid monitoring</p> <p> 47.50 [Hz] – 50.07 [Hz]</p>		<p> Set min. and max. switch-on frequency after grid monitoring.</p>
<p> Min. switch-on voltage after grid error</p> <p>Max. switch-on voltage after grid error</p>		<p> Set min. and max. switch-on voltage after grid monitoring.</p>
<p> Min. switch-on frequency after grid error</p> <p>Max. switch-on frequency after grid error</p>		<p> Set min. and max. switch-on frequency after grid monitoring.</p>
<p> Monitoring time PV voltage</p>		<p> Set time for voltage monitoring.</p>
<p>Monitoring time grid voltage</p>		<p> Set time for voltage monitoring.</p>
<p> Waiting time after grid error</p>		<p> Set wait time for grid monitoring.</p>
<p> Advanced islanding detection</p>		<p>NOTE: NOTE: Grid operators require shutdown of the device with standalone grid detection. More detailed information at: [See section 10.5 Page 71]</p>
<p> ROCOF operation mode passive  Off On</p>		<p> Activate passive grid influence by application of a frequency.</p>
<p>ROCOF operation mode active  Off On</p>		<p> Activate active grid influence by application of a frequency.</p>
<p> Exten. ROCOF</p>		<p> Activate active grid influence by additional reactive power feed-in.</p>
<p> Frequency shift  Off On</p>		<p> Activate frequency shift.</p>
<p> Pulse period repetition time</p> <p> 40 – 6000 [ms]</p>		<p> Define period for detection.</p>

<p>ROCOF threshold level 1 value  0.1 – 6.0 [Hz / s]</p> <p>ROCOF threshold level 2 value  0.1 – 6.0 [Hz / s]</p> <p>ROCOF threshold level 1 time  0.10 – 5.00 [s]</p> <p>ROCOF threshold level 2 time  0.10 – 5.00 [s]</p>		<p>Define threshold for ROCOF.</p> <hr/> <p>Define time value for ROCOF.</p>
<p>ROCOF proportionality factor</p> <p> -5000 – 5000 [⁰/₀₀ / Hz]</p> <p> Status</p>		<ol style="list-style-type: none"> 1. Define the proportionality factor. 2. Confirm the action field.
<p>Change password for "installer"</p> <p> Password of the logged-on user New password for the "installer" access Confirm new password</p>		<ol style="list-style-type: none"> 1. Enter old password. 2. Enter a new, secure password. 3. Confirm and apply new password.
<p>Change password for "user"</p> <p> Password of the logged-on user New password for the "user" access Confirm new password</p>		<ol style="list-style-type: none"> 1. Enter old password. 2. Enter a new, secure password. 3. Confirm and apply new password.
<p>10 min. mean value</p> <p> Overvoltage averaging</p>		<p>Set the voltage via averaging.</p>
<p> Counter / inverter voltage drop</p>		<p>Set the voltage.</p>
<p>Overvoltage protection</p> <p>Transient overvoltage protection</p> <p> 114,8 – 148,0 [% Unom]</p> <p>Password protection</p> <p> Status</p>		<p>Set the transient overvoltage protection.</p> <p>NOTE: Shutdown carried out within a grid cycle.</p> <ol style="list-style-type: none"> 1. Activate optional password protection. 2. Confirm the action field.
<p>Power Limitation</p>		<p>NOTE: The output power of the device can be set permanently to a lower value than the maximum output power by the internal power limitation. This may be necessary in order to limit the maximum power rating of the system at the grid connection point, upon the grid operator's request.</p>
<p>Internal</p> <p>Power Limitation</p> <p> Status</p>		<p>NOTE: Opportunity to limit the power internally More detailed information at: [See section 10.4.1 ▶ Page 69]</p> <p>Specify the activation status.</p>

<p> Maximum apparent power Slim  1000 – S_{max} [VA]</p>	<p> NOTE: The max. apparent power limits the internal power of the device.  Enter the value or set the value using the slider.</p>
<p> Maximum active power Plim  1.0 - 100.0 [% Slim] Password protection  Status</p>	<p>  Enter the value or set the value using the slider.</p>
<p> EPC (extended power control) Fallback power  0 – 1000 % Timeout  3 – 100000 s</p>	<p> NOTE: EPC settings</p> <p> 1. Set fallback power. 2. Set time until shutdown takes place. 3. Apply the values using the Apply button.</p>
<p> Power rampup active Power rampup gradient  1 – 600 [% / min] Power rampup on every connect  Status Rampup on first connect  Status Rampup after grid failure  Status Password protection  Status</p>	<p> NOTE: Power ramp-up is used to ramp up the power gradually. More detailed information at: [See section 10.4.2 Page 70]  Set increase.</p> <p>1. Activate option. 2. Activate optional password protection. 3. Confirm action field</p>
<p> Priority mode  Q priority P priority</p>	<p>  Set priority for reactive power – Q or active power – P. NOTE: When it comes to P priority, the reactive power adjustment range is limited subject to the active power that is currently available and fed in.</p>
<p> Activation threshold with overfrequency  50.2 – 70 (Hz) Activation threshold with underfrequency  40 – 45 (Hz)</p>	<p> 1. Set frequency thresholds for activating the power limitation with overvoltage. 2. Set the frequency thresholds for activating the power limitation with undervoltage.</p>
<p> Power reduction P(U)</p>	<p> NOTE: To prevent the device from shutting down due to overvoltage protection, the active power can be regulated in addition to reactive power control in order to reduce the active power feed-in whereby the output voltage is reduced.</p>
<p> P(U) operation mode  Off On</p>	<p>  Activate the control process. Off: Deactivates dynamic grid support using dynamic reactive current. Dynamic grid support remains active on account of immunity to interference.</p>

<p> Reference power  Instantaneous power Nominal power</p>	<p> Select the power-dependent control method.</p>
<p> Rated voltage  Maximum phase voltage Positive phase sequence voltage</p>	<p> Select the voltage to be rated. Specifies which voltage is evaluated in a three-phase system.</p>
<p> Hysteresis mode  Off On</p>	<p>NOTE: Hysteresis mode affects the shutdown response of P(U).  Activate the mode.</p>
<p> Deactivation gradient  1 - 65534 [% / min]</p>	<p>  Set gradients for the voltage limitation.</p>
<p> Deactivation time  0 – 60000000 [ms]</p>	<p>  Specify the time for voltage reduction.</p>
<p> Settling time  200– 120,000 [ms]</p>	<p>  Specify the settling time.</p>
<p> Active curve  1 - 5</p>	<p>  Select active curve. NOTE: Up to 5 characteristic curves can be configured independently and one of them can be activated for regulation each time.</p>
<p> Number of nodes  2 – 5</p> <p>Power  0.0 -100.0 [%]</p> <p>Voltage  0.0 -126.0 [%]</p> <p>Password protection  Status</p>	<p>  Specify the number of nodes.</p> <p> Specify power for 1st, 5th ... node as a percentage of the maximum power.</p> <ol style="list-style-type: none"> 1. Specify voltage for 1st, 5th ... node as a percentage of the maximum voltage. 2. Activate optional password protection. 3. Confirm the action field.
<p> Activation threshold  230V – 276V</p>	<p>  Specify the activation threshold. NOTE: If the 10 min mean value of the voltage exceeds the activation threshold, then the function is enabled. The power level is adjusted in such a way that the instantaneous effective voltage value does not exceed the activation threshold value.</p>
<p> Deactivation threshold  230V – 276V</p>	<p>  NOTE: If the 10 min mean value of the voltage falls below the deactivation threshold, then the function is disabled.</p> <ol style="list-style-type: none"> 1. Specify the deactivation threshold.

Upload/download		NOTE: Opportunity to save log files and save and import parameter data
Download service log data		Save service log data to external storage media.
Download service log data without yields		Save log data without yields to external storage media.
Download a set of parameters		Save a set of parameters to external storage media.
Document a set of parameters		Issue or print documentation of a set of parameters as a PDF.
Transfer a set of parameters		Load a set of parameters from external storage media.



NOTE

With regard to the selection of country settings, KACO new energy attests:

1. that the relevant certificates are only valid if the corresponding country settings have been selected.
2. that all configured grid parameters must be configured in accordance with the requirements of the grid operators.
3. that the configuration of parameters using IEEE 1547: 2003 table 1 is possible but is only permitted if it is requested by the grid operators.

9.5 Monitoring the device

The device has an integrated web server. This makes it possible to monitor and record the operating state and yield of your PV system.

USB interface

Use an external USB storage device to read operating data saved on the device.

Reading log data

1. Connect a suitable USB storage device to the USB interface on the connection circuit board.
2. Open the "Log data view" menu.
3. Select "Save to USB".
4. Select the desired log data using the 4-way button.
5. Press the `Enter` button.

⇒ The device saves the selected log data to the USB storage device.



NOTE

The USB interface is approved solely for use with USB flash storage devices ("USB sticks"). The maximum available current is 100 mA. If a device with a higher power requirement is used, the power supply for the USB interface automatically shuts down to protect the device from damage.

Web server

This device has an integrated web server. After configuring the network and activating the web server in the Settings menu, you can open the web server from an internet browser. The language version of the website delivered by the web server is adapted dynamically to the pre-set language preferences in your Internet browser. If your Internet browser requests a language that is unknown to the device, the web server uses the menu language set in the device.

↻ You have connected the device to your network.

1. When using a DHCP server: Activate DHCP.
2. For manual configuration (DHCP off):

3. Open the Settings/Network menu.
4. Assign a unique IP address.
5. Assign a subnet mask.
6. Assign a gateway.
7. Assign DNS server.
8. Save your settings.

Using the web server

To avoid problems with incompatibility, use the most recent version of your Internet browser. JavaScript must be enabled in the browser settings to display the web server correctly.



NOTE

You can also access the web server of the device via the Internet. To do this, additional settings of your network configuration, particularly your internet router, are required. Note that communication with the device is carried out over an unsecured connection, particularly in the case of a connection via the internet.

- ↻ Configure the Ethernet interface.
- ↻ Connect the Ethernet cable.
 1. Open an Internet browser.
 2. In the address field of the internet browser, enter the IP address of the device and open the site.
- ⇒ The internet browser displays the home screen of the web server.

After it has opened, the web server displays information about the device as well as the current yield data.

– Feed-in power	– Generator power
– Status	– Generator voltage
– Grid power	– Unit temperature
– Grid voltage	–

Tab. 4: Display of measurement and yield data

In order to display and export yield data, proceed as follows:

Select the display period

1. Call up the web server
2. Select the display period by selecting one of the buttons: `daily view`, `monthly view`, `yearly view` or `overview`.

Filtering the display period (only possible with daily view)

1. Open the web server.
2. Select the daily view.
3. To show or hide measurements, select or deselect the corresponding checkboxes in the “Choose view” area.

Exporting data

1. Filter the display data if necessary.
2. Select the display period if applicable (daily, monthly, yearly or overview).
3. Press the “Export data” button.
4. Save the file.



NOTE

Regardless of the display data selected in the “Choose view” area, an export file always contains all measurement data and yield data available for the selected period.

9.6 Performing a firmware update

You can update the software of the device to a new version using the integrated USB interface. Use a FAT32-formatted USB stick to do this.

Do not use any storage media with an external power supply (for example: an external hard disk).

New functions can be added to the device via firmware updates.



NOTE

Ensure the active DC power supply of the device

It is only possible to update all of the device's components to the most current firmware version in this operating state.

CAUTION

Damage to the device from faulty power supply

The update can fail if the power supply is interrupted during the update process. Parts of the software or of the device itself may be damaged.

1. Never disconnect the DC and AC power supply for or during a firmware update.
2. Do not remove the USB stick during the firmware update.

Preparing a firmware update

1. Download the firmware update file from the KACO web site www.kaco-newenergy.com and store it on your hard disk.
 2. Extract the complete firmware update file to a USB stick.
- ⇒ Perform the firmware update.



NOTE

In order to adopt new country-specific parameters, the set user country must be changed prior to every firmware update.

1. Once the firmware update is complete, you can return to the original user country.



NOTE

The firmware update can take several minutes. The "Operating" LED flashes during the update process. The device may restart several times as required.

The following message appears if the DC power supply is too low: "DC power supply too low! Perform update anyway? .

In this case, select "No" and perform the update with a stable power supply.

Performing a firmware update

⌚ Ensure that the power supply is connected.

1. Connect the USB stick to the device.
 - ⇒ The message appears on the display: "Software found. Load?"
2. If you would like to perform the update, press the "Yes" button. If "No", pressing the "Enter" button cancels the update process and the device goes into feed-in mode.
 - ⇒ The device begins the update.
 - The update has been imported in full when the message „Software update successful.“ appears.
 - If the update fails, the message "Software update incomplete" appears.
3. When an error occurs, the update process must be repeated.

You can check to see if the update was successful in the menu:

Displaying the firmware version

☞ Open the Information / SW version menu.

⇒ The device will display the versions and checksums of the software that is currently loaded.

9.7 Access via Modbus



NOTE

In order to make use of the Modbus functionality, we recommend using the “SunSpec-Modbus-Interface” specification we have made available for the firmware version installed on your device.

Follow the description in the document “Modbus-Protokol.pdf” in order to use the two Excel files with a high level of process reliability.

⌚ Firmware version of device is identical to the specifications of the Sunspec® Modbus®.

1. Enable the entry `Network - Modbus TCP - Operation mode / Network services - Modbus TCP - Operation mode` in the menu on the device or on the web interface.

2. If necessary, allow `write access`.

3. Set up the `Port` for access. [Default: 502]

⇒ Access via Modbus enabled.

10 Specifications

10.1 Reactive power control

Reactive power can be used in electrical energy supply networks to bolster the level of voltage. As such, feed-in inverters can contribute to statistical voltage stability. Reactive power brings about a voltage drop at the inductive and capacitive components of the equipment which can either bolster or reduce the level of voltage. If the generating plant draws inductive reactive power while active power is being fed in, part of the voltage swing caused by the active power feed can be compensated for by the supply of reactive power.

This reactive power mode and the respective control process are specified by the grid operator. If no control process has been specified, then the system should be operated using a reactive power specification of 0%.

10.1.1 Operating power range depending on grid voltage

The device can be operated within the respective fixed voltage range provided. The maximum apparent power is stated in the following table. In the event of undervoltage determined by the maximum continuous current subject to the grid voltage.

Voltage - devices with U_N : 220 V / 380 V; 230 V / 400 V; 240 V / 415 V	Voltage - devices with U_N : 270V / 480V	Maximum apparent power [p.u.]
≥ 400	≥ 480	1.04
390	468	1.04
380	456	1.0
360	432	0.95
342	412	0.90
323	388	0.85

Tab. 5: Maximum continuous apparent power depending on grid voltage

The following figures show the reactive power-active power operating range for devices with a nominal voltage of U_N 220/380, 230/400, 240/415. Devices with a nominal voltage of 277/480 correspond to the first figure taking into consideration the voltage values in this table.

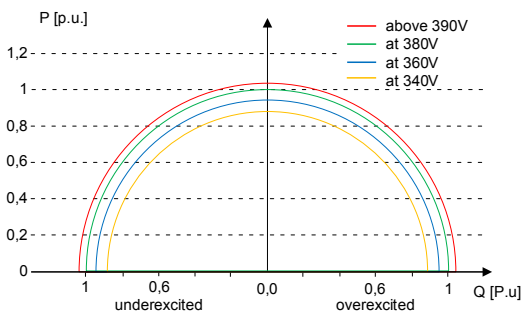

Fig. 37: P-Q operating range for devices above 12 kVA

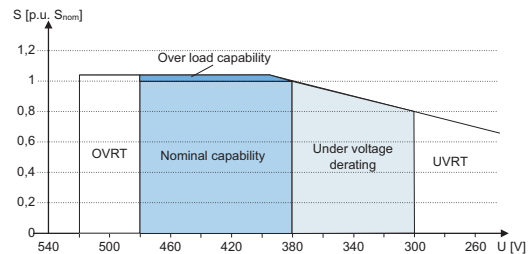

Fig. 38: Apparent power subject to the grid voltage

10.1.2 Dynamics and accuracy

In all control methods the specified target value at the inverter’s connection terminals is adjusted using a stationary deviation of the reactive power of maximum 2% S_N . This maximum deviation always relates to the specified value as reactive power. If the shift factor $\cos \varphi$ is specified in the control method, then the deviation relates to the reactive power value brought about by the current power level.

The transient response of the control methods is determined by a PT-1 filter. In this case, the settling time corresponds to 5 Tau, or in other words, achieving approx. 99% of the final value for a PT-1 filter. Subject to the control method selected, there are also other parameters that determine dynamic behaviour.

10.1.3 Reactive power functions

The following functions for controlling the reactive power are implemented in the devices listed above:

- $\cos \varphi$ constant
- Q constant

- $\cos \varphi / (p/p_n)$
- Q(U) 10 nodes
- Reactive power is prioritised in each method. The maximum possible active power that can be fed in is reduced in line with the P-Q operating range when a specific reactive power level is specified.

cos φ constant

In constant $\cos \varphi$ mode, the specified shift factor $\cos \varphi$ is permanently set by the inverter. In doing so, the reactive power level is set in line with $Q=P \cdot \tan \varphi$ as a function of the power that continuously generates the specified shift factor $\cos \varphi$. If the specification is changed, the new value is adopted by way of a filter in a muted manner. The settling time is 1s with the transient response of a first-order filter (PT-1) with a time constant of $\tau=200\text{ms}$. The specified shift factor can be configured on the display or by way of communication via the KACO RS485 protocol and MODBUS/SunSpec.

If the applicable grid code stipulates that the $\cos \varphi$ should react to the target value slower than the configured $\tau=200\text{ms}$ by way of a defined gradient or settling time, this gradient or settling time must be implemented in the system control.

If the timeout is set to 0 seconds, this is suitable for lasting preservation.

Q constant

In Q-constant mode, the specified reactive power value is permanently set by the inverter. If the specification is changed, the new value is adopted by way of a filter in a muted manner. The settling time is 1s with the transient response of a first-order filter (PT-1) with a time constant of $\tau=200\text{ms}$. The specified reactive power can be configured on the display or by way of communication via the KACO RS485 protocol and MODBUS/SunSpec.

If the applicable grid code stipulates that the reactive power should react to the target value slower than the configured $\tau=200\text{ms}$ by way of a defined gradient or settling time, this gradient or settling time must be implemented in the system control.

If the timeout is set to 0 seconds, this is suitable for lasting preservation.

cos φ / (P/P_n)

In the $\cos \varphi / (P / P_n)$ operating mode, the setpoint value of $\cos \varphi$ and the setpoint for the reactive power derived from it are continuously calculated depending on the actual power level. This function ensures that grid support is provided by the reactive power when a significant voltage boost is anticipated due to a high feed level. In this case, a characteristic curve is specified which can be used to configure up to 10 nodes, value pairs for active power and $\cos \varphi$. The active power is entered as a % in relation to the nominal power. Other parameters allow you to limit functionality and to limit activation to certain voltage ranges.

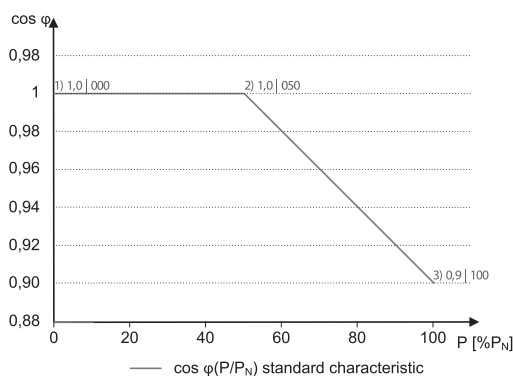

Fig. 39: $\cos \varphi / (P/P_n)$ standard characteristic curve with 3 nodes

Q(U) 10 nodes

When it comes to Q(U) 10 nodes, the nominal value of the reactive power is continuously calculated depending on the grid voltage. This function ensures that grid support is provided by the reactive power as soon as the voltage actually deviates from the target voltage. In this case, a characteristic curve is specified which can be used to configure up to 10 nodes, value pairs for voltage and reactive power. Other parameters allow you to limit functionality and to limit activation to certain voltage ranges as well as parametrise the transient response.

The zero sequence voltage is used to calculate the reactive power target for three-phase units.

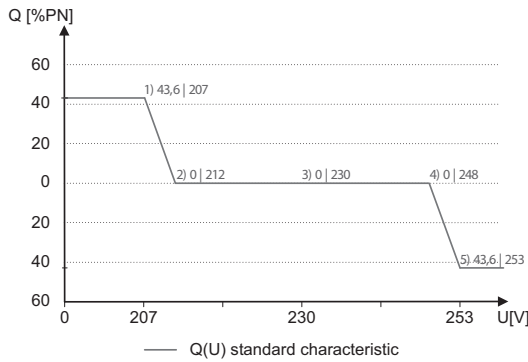

Fig. 40: Q(U) standard characteristic curve with 5 nodes

10.1.4 Parameters for reactive power control

Country-spec. Settings	Menu Setting level	Display/Setting	Action in this menu/meaning
		cos-phi const. ⚙️ 1 – 0.3	Specified displacement factor
		⚡ Over-excited under-excited	Reactive power mode Under-excited relates to inductive load, over-excited relates to capacitive load.
		Q constant ⚙️ 0 – 100 [% S _{max}]	Specification as a % of the maximum power
		☰ Under-excited over-excited	Reactive power mode Under-excited relates to inductive load, over-excited relates to capacitive load.
		cos-phi(P/Plim) Settling time ⚙️ 200 – 30000 [ms]	Determines the dynamic behaviour in the event of a change in the cos φ set value. With a change of the active power or the lock-in and lock out voltage, the cos φ is changed according to a PT-1 characteristic curve with a settling time of 5 Tau.
		Lock-in voltage 23V – 287V	The control is activated above this voltage.
		Lock-out voltage ⚡ 23V – 287V	The control is deactivated below this voltage.
		Number of nodes ⚙️ 2 – 10	Specify the number of nodes for the cos φ/(p/pn) characteristic curve
		1st node ... 10th node ☰ Voltage Reactive power Excitation ⚙️ 0 – 100 [% S _{max}]	Power of the node as a percentage of the maximum power. For the 1st node, the power must be 0%; for the last node, the power must be 100%. The power values of the nodes must increase continuously. Note: Storage inverters only for feed-in operation
		⚡ 0 – 100 %	cos φ of the node
		⚡ Over-excited under-excited	Reactive power mode Under-excited relates to inductive load, over-excited relates to capacitive load.
		Q(U) 10 nodes	
		Lock-in power ⚙️ 0 – 100 [% S _{max}]	Power threshold, function is activated if limit value is exceeded.
		Lock-out power ⚙️ 0 – 100 [% S _{max}]	Power threshold, function is activated if limit value is undershot.

Country-spec. Settings	Menu level	Display/Setting	Action in this menu/meaning
		Lock-in time ⚙️ 0 – 60 [s]	Length of time that the active power must remain below the lock-in power level before control is deactivated.
		Lock-out time ⚙️ 0 – 60 [s]	Length of time that the active power must remain below the lock-out power level before control is deactivated.
		📏 Downtime ⏱️ 0-10000 [ms]	If the voltage switches from a characteristic curve section with Q=0 to a characteristic curve section with Q≠0 under active control, then the reactive power setting process is delayed by the set dead time. Once the dead time has expired, the control circuit is no longer subject to a delay and the set transient time determines the transient behaviour.
		Rise Outg. grad. & Fall. Outg. grad. ⏸️ increasing decreasing	In addition to configuring the dynamic behaviour using the transient time corresponding to a first-order filter, the reactive power setting can be determined by a maximum gradient - this means the maximum change in the reactive power per time period.
		⚙️ 1 – 60000 [% S_{max} /min]	Maximum change in the reactive power % S_N /min in the event of a change to over-excited mode NOTE: The gradient is overlaid with the settling time.
		Min. cos-phi Q1 - Min. cos-phi Q4	In the event of a significant voltage deviation, the maximum reactive power adjustment range can be limited by a minimum cos φ in order to prevent an excessive reactive power supply and, as a result, a significant reduction in the maximum active power that can be fed in.
		Q1	Minimum cos φ in over-excited operating mode (in-feed).
		Q4	Minimum cos φ in under-excited operating mode (in-feed).
		Q2	Minimum cos φ in over-excited operating mode (charge).
		Q3	Minimum cos φ in over-excited operating mode (charge).
		Priority mode ⏸️ Q priority P priority	P priority can be selected as an alternative to the standard setting Q priority. When it comes to P priority, the reactive power adjustment range is limited subject to the limited apparent power of the inverter and the active power that is currently available and fed in.
		Active curve ⏸️ 1 – 4	Up to four characteristic curves can be configured independently and one of them can be activated for regulation each time.
		Reset the curve	Reset active curve to the factory setting, depending of the country setting.
		Number of nodes ⚙️ 2 – 10	Specify the number of nodes for the Q(U) characteristic curve.
		1st node ... 10th node ⚙️ 0V - Max. voltage in continuous operation	Voltage of the node in volts. The voltage values of the nodes must increase continuously. At voltages below the 1st node and voltages above the last node, the reactive power value of the 1st or last node is used each time.
		1 – 0.3	Reactive power of the node as a percentage of the maximum power
		Over-excited under-excited	Reactive power mode Under-excited relates to inductive load, over-excited relates to capacitive load.

10.2 Active power regulation

10.2.1 P target value









The function “P target value” is integrated into the MPP tracking of the inverter on all PV inverters. The P target value is continuously re-calculated on the basis of the MPP tracking algorithm.

10.2.2 P limit

The function “P limit” is available for limiting the maximum feed-in power. If necessary, this can be used to reduce the maximum possible feed of an inverter, e.g. for managing bottlenecks for the operator of the distribution grid.

P limit is only available via the MODBUS/SunSpec inverter model 123 Immediate Inverter Controls and via RS485 communication. You can find detailed information on the communication protocol at www.kaco-newenergy.de in the “Software” subsection of the “Downloads” section.

When a target value is received for P limit, the output power of the inverter is limited to the specified power value. If the limit value is changed, the new value is adopted by way of a filter and a gradient limitation. The current power may be below the specified limit value because the available power (PV) or the target power value (storage) may be below the specified limit value. Depending on the inverter series, the settling time and gradient limitation may be adjustable.

Power Limitation [WMaxLimPct]	 0 – 100 [%]	 	Specifies the standard power in the event of a communication timeout. If no active power/reactive power command is received within the configured timeout, the inverter sets the power to the configured fallback power.
Timeout [WMaxLimPct_RvrtTms]	 0 – 1000 [s]	 	Specifies the timeout time after which the inverter sets the fallback power in case of a communication failure. This means that the inverter has not received a new power limit value. If the timeout is set to 0 seconds, this is suitable for lasting preservation.
Settling time [VArPct_RmpTms]	 1000 [ms]	 	Non-configurable settings 1 s.

10.2.3 Voltage-dependent power reduction P(U)

If it is not possible to compensate adequately for increase in voltage in the upstream distribution network by intake on reactive power, it may be necessary to curtail the active power. In this case, P(U) control is available for making optimum use of the capacity of the upstream grid.

P(U) control reduces the active power that is fed in as a function of the grid voltage using a prescribed characteristic curve as a basis. P(U) control is implemented as an absolute power limit. The actual power of the inverter may vary freely below this limit due to a possible fluctuation in the available power or the target value, but at no time increases above the absolute power limit.

[See figure 41 ▶ Page 62] and [See figure 42 ▶ Page 62] are two examples of configuration. In figure 1 without hysteresis, the function is activated as soon as the voltage exceeds the configured voltage of data point 1 (dp1). The power limit follows the characteristic curve, a straight line between dp1 and dp2. The function is deactivated as soon as the voltage falls below dp1. In [See figure 42 ▶ Page 62], the function is activated as soon as the voltage exceeds the configured voltage of dp2. In this case, dp1 does not result in activation of the function because the power limit remains at 100%. The power limit follows the characteristic curve, a straight line between dp2 and dp3. However, because hysteresis is activated, the power limit is not increased when the voltage drops. The function is deactivated as soon as the voltage falls below dp1.

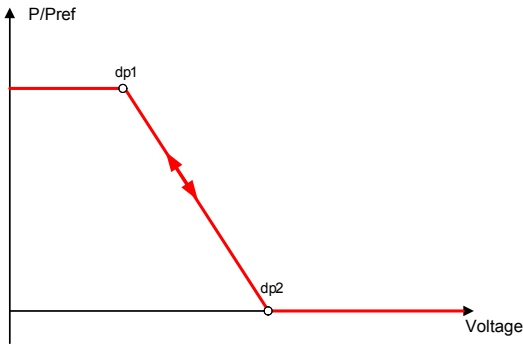

Fig. 41: Example characteristic curve without hysteresis

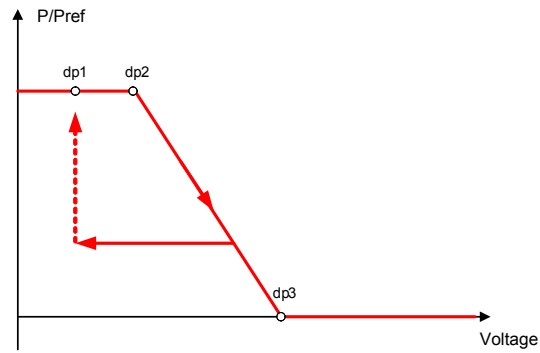



Fig. 42: Example characteristic curve with hysteresis and a deactivation threshold below the activation threshold

10.2.3.1 Parameters for P(U)

Country-spec. Settings	Menu Setting level	Action in this menu/meaning
	P(U) operation mode <input type="checkbox"/> Off <input checked="" type="checkbox"/> On	<input checked="" type="checkbox"/> Activate the control process. <input type="checkbox"/> Off: Deactivates dynamic grid support using dynamic reactive current. Dynamic grid support remains active on account of immunity to interference.
	Reference power <input type="checkbox"/> Instantaneous power <input checked="" type="checkbox"/> Nominal power	Specifies the power reference for the characteristic curve. 100 % here corresponds to the nominal power or the actual power at the time the function was activated, the time when the voltage passes the configured node.
	Rated voltage <input type="checkbox"/> Maximum phase voltage <input checked="" type="checkbox"/> Positive phase sequence voltage	<input checked="" type="checkbox"/> Select the voltage to be rated. Specifies which voltage is evaluated in a three-phase system.
	Hysteresis mode <input type="checkbox"/> <input checked="" type="checkbox"/> Off <input type="checkbox"/> On	Off: In non-hysteresis mode, the active power is increased immediately with dropping voltage. On: In hysteresis mode, the power is not increased with dropping voltage.
	Deactivation gradient ⚙️ 1 - 65,534 [% / min]	If the available power is above the actual output at the time of deactivation, the power increase back to the maximum power is limited. The limitation is implemented by an absolute power limitation that increases with a continuous gradient up to the maximum power. The actual power of the inverter may vary freely below this limit due to a possible fluctuation in the available power or the target value, but at no time increases above the absolute power limit.
	Deactivation time ⚙️ 0 – 60000000 [ms]	Only evaluated with activated hysteresis mode: Monitoring time during which the voltage must remain below the lowest configured node before the function is deactivated.
	Settling time ⚙️ 100 – 1,200,000 [ms]	Determines the dynamic behaviour in the event of a change in the active power set value. With a voltage change, the active power is changed according to a PT-1 characteristic curve with a settling time of 5 Tau. Note: The settling time is overlaid with the increasing and decreasing gradient.

Country-spec. Settings	Menu level	Display/Setting	Action in this menu/meaning
		Number of nodes ⚙️ 2 - 5	Up to five nodes for voltage [V] and power [% Pref] are configurable. The power value of the first and last value pair is also used as the maximum or minimum active power value that is valid across the limits of the characteristic curve.
		Power ⚙️ 0.0 -100.0 [%]	
		Voltage ⚙️ 0.0 -126.0 [%]	
		☰☲☳☴☵☶☷ Active curve ⚙️ 1 - 5	 Select active curve. NOTE: Up to 5 characteristic curves can be configured independently and one of them can be activated for regulation each time.

10.2.4 P(f)

Adjusting the active power P(f) in the event of overfrequency

Feed-in inverters must assist with frequency stability in the grid. If the grid frequency leaves the normal tolerance range (e.g. ± 200 mHz), then the grid will be in a critical state. In the event of overfrequency, there is a generation surplus, in the event of underfrequency, there is a generation deficit.

PV systems must adapt their feed-in power relative to the frequency deviation. In the event of overfrequency, the power adjustment is determined by a maximum feed-in limit. The actual power of the inverter may vary freely below this limit due to a possible fluctuation in the available power or the target value, but at no time increases above the absolute power limit.

$$P_{max-limit} = P_M + \Delta P$$

Fig. 43: Equation 1

$$\Delta P = g \cdot P_{ref} \cdot (f_1 - f)$$

Fig. 44: Equation 2

Gleichung 1 [See figure 43 [▶ Page 63] definiert die maximale Grenze mit ΔP entsprechend Gleichung 2 [See figure 44 [▶ Page 63], P_M die Momentanleistung zum Zeitpunkt der Aktivierung und P_{ref} die Referenzleistung. In the case of PV inverters from KACO, P_{ref} is defined as P_M , the current power at the time of activation. f is the current frequency and f_1 is the specified activation threshold.

$$\Delta P = \frac{1}{s} \times \frac{(f_1 - f)}{f_n} \times P_{ref}$$

Fig. 45: Equation 3

$$g = \frac{1}{s \cdot f_n}$$

Fig. 46: Equation 4

In some standards, the power adjustment is specified by a drop (s) instead of a gradient (g), as shown in equation 3 [See figure 45 [▶ Page 63]. The drop s can be transformed into a gradient g in accordance with equation 4 [See figure 46 [▶ Page 63].

The frequency f remains above the activation threshold f_1 during an overfrequency incident. Consequently, the expression $(f_1 - f)$ is negative and ΔP corresponds to a reduction in the feed-in power.

The measurement accuracy of the frequency is greater than 10 mHz.

The specific mode of operation of the function is specified by the grid operator or the pertinent standards or the grid connection guidelines. The configurability of the function makes it possible to satisfy a wide variety of standards and guidelines. Certain configuration options are not available in some country settings because the pertinent standards or grid connection guidelines prohibit adjustments.

Adjusting the active power $P(f)$ in the event of underfrequency

Some grid connection guidelines also require adjustment of the active power $P(f)$ in the event of underfrequency. Due to the fact that PV systems are typically run at the maximum power point, there are no power reserves for increasing the power in the event of underfrequency.

However, in the event that the system power is reduced due to market regulation, it is possible to increase the active power up to the power level available. Because the inverter is unable to distinguish between P constant target values for obligatory bottleneck management by the grid operator and for market regulation, this needs to be implemented in the site-specific infrastructure of system control.

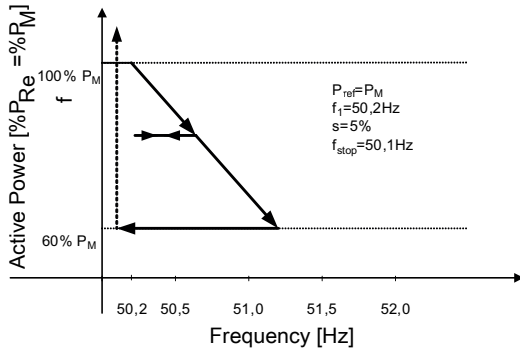

Fig. 47: Example behaviour with hysteresis (mode 1)

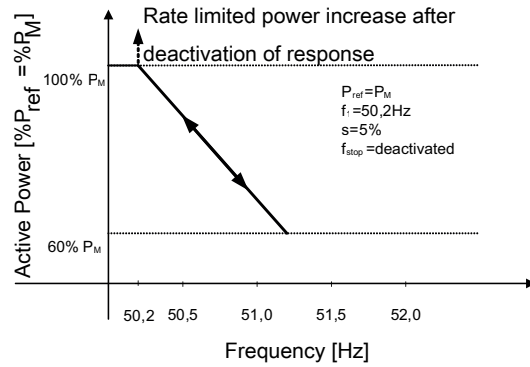

Fig. 48: $P(f)$ example characteristic without hysteresis Mode 2

10.2.4.1 Parameters for $P(f)$

Country-spec. Settings	Menu Display/Setting	Action in this menu/meaning
	P(f) operation mode ☰ Off Mode 1 Mode 2	Activate or deactivate function. Mode 1: With hysteresis activated. Mode 2: Without hysteresis activated.
	Activation threshold with overfrequency ⚙️ 50.2 – 70 (Hz) Activation threshold with underfrequency ⚙️ 40 – 45 (Hz)	Activation threshold (f1) overfrequency: Determines the frequency threshold for activating the function in case of overfrequency incidents. The active power adjustment is activated if the frequency rises above the configured value and mode 1 or 2 is activated. In mode 2, the function is deactivated if the frequency falls below the configured value. Activation threshold (f1) underfrequency: Determines the frequency threshold for activating the function in case of underfrequency incidents. The active power adjustment is activated if the frequency falls below the configured value and mode 1 or 2 is activated. In mode 2, the function is deactivated if the frequency rises above the configured value.
	P(f) intentional delay ⚙️ 0 – 5,000 [ms]	The activation of the function based on the activation threshold is delayed by the configured time. Note 1: This function is regarded as critical for the stability of the transmission grid and is therefore prohibited by several national grid connection regulations. Note 2: This function is stipulated as a requirement by some domestic grid connection directives in order to prevent any negative impact on island detection. However, $P(f)$ has no negative impact on KACO's enhanced island detection.

Country-spec. Settings	Menu level	Display/Setting	Action in this menu/meaning
		Frequency of the maximum deactivation threshold  45 - 50.2 (Hz) Frequency of the minimum deactivation threshold  45 – 50,2 (Hz)	<p>Deactivation range lower limit:</p> Only evaluated in mode 1. The function is deactivated if the frequency returns to the deactivation range and remains in this range for the duration of the deactivation time. <p>Deactivation range upper limit:</p> Only evaluated in mode 1. The function is deactivated if the frequency returns to the deactivation range and remains in this range for the duration of the deactivation time.
		P(f) deactivation time  0 – 3600 [s]	Only evaluated in mode 1. The function is deactivated if the frequency returns to the range between the minimum and maximum deactivation threshold and remains in this range for the duration of the deactivation time.
		P(f) deactivation gradient  1 - 65,534 [% / min]	If the available power is above the actual output at the time of deactivation, the power increase back to the maximum power is limited. The limitation is implemented by an absolute power limitation that increases with a continuous gradient up to the maximum power. The actual power of the inverter may vary freely below this limit due to a possible fluctuation in the available power or the target value, but at no time increases above the absolute power limit.
		Maximum dynamic gradient frequency  50.22 – 70.5 [Hz] Minimum dynamic gradient frequency  45 – 50 [Hz]	<p>Dynamic gradient maximum frequency:</p> If dynamic gradient mode is activated, the gradient is calculated in order to guarantee a linear power adjustment and reach the maximum charging power if the frequency rises to the maximum configured frequency. <p>Dynamic gradient minimum frequency:</p> If dynamic gradient mode is activated, the gradient is calculated in order to guarantee a linear power adjustment and reach the maximum feed-in power if the frequency drops to the minimum configured frequency.
		P(f) settling time  200 – 2,000 [ms]	Determines the dynamic behaviour in the event of a change in the active power limit. In the event of a change in frequency, the active power is altered subject to a PT-1 characteristic curve using a settling time of 5 Tau. The settling time is overlaid with the increasing and decreasing gradient.
		 Output gradient limitation increase & Output gradient limitation decrease  1 – 65534 [% / min]	 Specifies the dynamic response on changing the active power for power increase and decrease. With a voltage change, the active power is changed with the specified gradient. Note: The gradient is overlaid with the settling time.

10.3 FRT

Dynamic grid support (Fault Ride Through)

A generation plant’s ability to remain immune to voltage drops and voltage spikes in the supply system is a key element in establishing a reliable energy supply. Immunity to interference ensures that brief disruptions do not result in a loss of generation capacity in a larger range of an interconnected grid. Grid support by a fast feeding of residual current also limits the spatial extent of the incident.

With its dynamic grid support by way of immunity, the device has this characteristic. The ability to remain on the grid is particularly relevant. The protective settings also determine the device’s ability to remain on the grid or not. Protective settings take the upper hand over the capacity of immunity to interference.

10.3.1 Dynamic grid support by way of immunity to interference

Interference immunity against undervoltage

Voltage drop above the limit curve in can be overcome without the need for shutdown from the grid. The feed-in power remains constantly within the limits of the maximum continuous current of the inverter.

If a reduction in power occurs, the power is brought back up to the pre-fault level within 100 ms of the voltage returning.

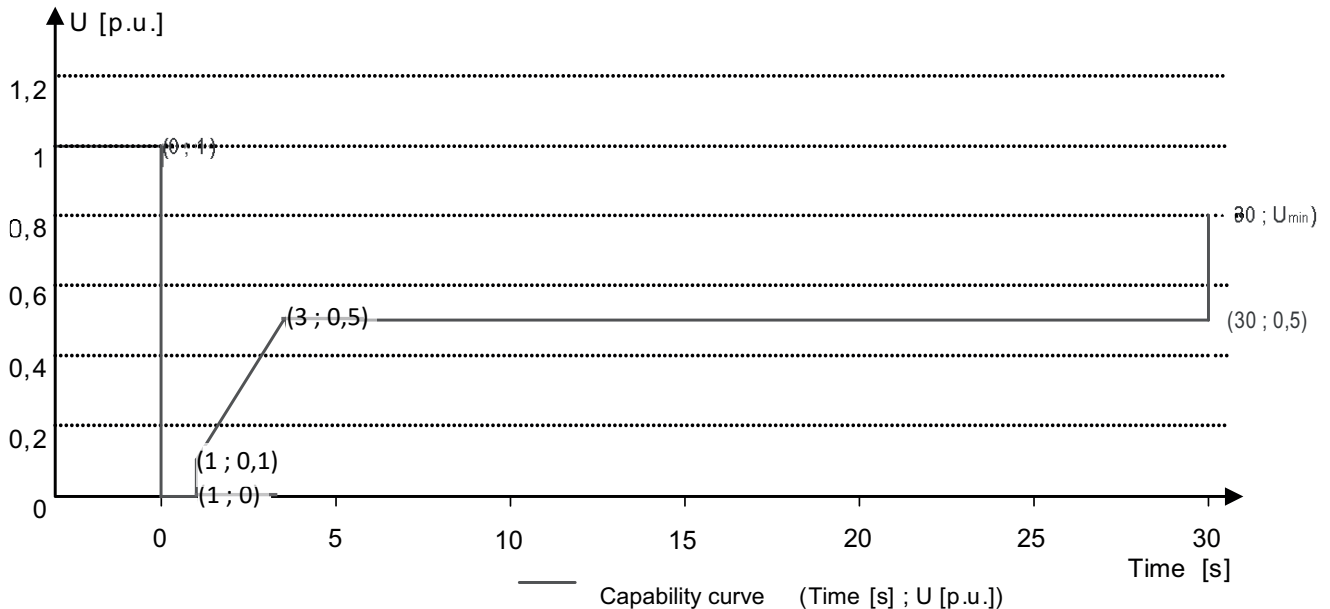

Fig. 49: Immunity to interference characteristic curve relative to the nominal voltage (p.u.) of the blueplanet 125.0TL3

Die Wechselrichter können Spannungsschwankungen durchfahren, sofern der Spannungspegel nicht länger als 100 s über dem Dauerbetriebsspannungsbereich bleibt und nicht über den kurzfristigen maximalen Betriebsspannungsbereich (bis 100 s) hinaus ansteigt. Die für jeden Wechselrichter spezifischen Werte finden Sie hier.

Der im Wechselrichter integrierte Schnittstellenschutz (Spannung, Frequenz, Anti-Islanding) ist in einem Bereich konfigurierbar, der das obige Verhalten zulässt. Wenn jedoch die Einstellung des Schnittstellenschutzes die Spannungs-Zeit-Kennlinie begrenzt, löst der Schnittstellenschutz aus und unterbricht die Durchfahrt wie konfiguriert.

10.3.2 Dynamic grid support using a fast feeding of residual current

When dynamic grid support using a fast feeding of residual current is activated, then residual current is fed in addition to the immunity to interference properties against drops and spikes described above.

The inverter adapts its current feed as soon as a drop or spike incident occurs in order to bolster the grid voltage. The support takes place in the event of voltage drop in the form of over-excited reactive current (corresponds to a capacitive load), in the event of voltage spike in the form of over-excited reactive current (corresponds to an inductive load). In the reactive current priority mode, the effective current is reduced to the extent necessary to comply with the limits of the maximum continuous current of the inverter.

A dip or swell is detected if either the normal operating voltage range setting is exceeded by at least one phase-phase or phase-neutral voltage, or if a step in the positive or negative sequence component of the voltage greater than the deadband setting occurs. The magnitude of the voltage step of the positive and negative sequence voltage equates to the difference between the pre-fault voltage and the actual voltage based on the reference voltage. The pre-fault voltage is calculated as a 50-periods mean value.

$$\Delta u = \frac{U - U_{50per}}{U_{ref}}$$

Fig. 50: Formula no. 1

The reactive current is adapted using a response time of <20 ms and a transient time of <60 ms after the incident has occurred. Responses to changes in the voltage during the incident or to the voltage recovery at the end of the incident take place with the same dynamic.

The formula for calculating the dynamic reactive current that is fed for the positive or negative phase sequence voltage is:

$$I_b = \Delta U * k * I_N$$

Fig. 51: Formula no. 2, depending on the nominal current I_N of the inverter

For the positive and negative phase sequence voltage, Δu equates to the difference between the pre-fault voltage and the current voltage based on the reference voltage. The pre-fault voltage is calculated as a 1-min mean value.

$$\Delta u = \frac{U - U_{1min}}{U_{ref}}$$

Fig. 52: Formula no. 3













On account of the definition of a voltage jump in pre-norm EN50549-2 and in VDE-AR-N 4120 and VDE-AR-N 4110, it is typically the case that another voltage jump is detected when the incident is at an end, when the fault is rectified and when the voltage returns to a normal state. The result of this is that in an active operation mode a dynamic grid support using a fast feeding of residual current remains active even after the incident has passed and that reactive current is fed in according to the formulae (2) and (3). Dynamic grid support using fast feeding of residual current is then deactivated after a configured minimum support time, usually 5 s.

$$I_b = (\Delta U_1 - t_b) * k * I_N$$

Fig. 53: Formula no. 4

10.3.3 Parameters for FRT

Country-spec. Settings	Menu Display/Setting level	Action in this menu/meaning
	FRT (Fault Ride Through)	NOTE: The device supports dynamic grid stabilization (Fault Ride-Through). NOTE: More detailed information at: [See section 10.3 ▶ Page 65]
	Operation mode – On Off Settings Manual Pre-defined zero current	Setting: Manual All parameters can be configured independently. Setting: Predefined zero current Dynamic grid support active on account of immunity to interference and zero current feed-in. During a voltage incident, the current in the inverter is reduced to zero. All parameters are pre-configured, only the activation threshold for zero current has to be configured.
	Priority – Reactive current limitation Dynamic reactive current	Priority: Reactive current priority Dynamic grid support active on account of immunity to interference and fast feeding of residual current. The inverter feeds additional reactive current according to the formulae (2) and (4). Priority: Effective current priority Dynamic grid support active on account of immunity to interference and fast feeding of active current with dynamic reactive current. The inverter feeds in as much active power as available. If, as a result of this, the maximum continuous current is not achieved, the device supplies additional reactive current according to the formulae (2) and (4) up to the limit of continuous current.
	Zero current under-voltage threshold Zero current over-voltage threshold 0 – 184 V / 253 – 340 V	If one or more phase/phase or phase/neutral conductor voltages move above the configured threshold, the inverter changes to zero current mode. The total current is regulated to virtually zero.

Country-spec. Settings	Menu level	Display/Setting	Action in this menu/meaning
		Reference voltage  $U_{< - U_{>}$	Nominal value of the phase/neutral conductor voltage used as a reference voltage for formula (1) and (3). Adjustable in the range from level 1 undervoltage protection to level 1 overvoltage protection.
		Constant K negative sequence dip Constant K negative sequence swell  k_{0-10}  2	Amplification factor for the negative sequence used in the calculation of the reactive current using formulae (2) and (4) Can be configured independently for drops and spikes.
		Constant K positive sequence dip & Constant K positive sequence swell  k_{0-10}  2	Amplification factor for the negative sequence used in the calculation of the reactive current using formulae (2) and (4) Can be configured independently for drops and spikes.
		Dead band  0 - 100 [% Uref]  10.0	Dynamic grid support through fast feeding of residual current activated in the case of voltage events with a voltage change greater than the dead band.
		Dynamic reactive current only  Off On	Standard: The reactive current according to the formulae (2) and (4) is fed as additional reactive current. This means that sum of the pre-fault and additional reactive current is fed in. Only dynamic: The reactive current according to the formulae (2) and (4) is fed in as absolute reactive current. This means that regardless of the reactive current before the voltage event, only the reactive current is fed in according to the formulae (2) and (4) is fed in during the voltage event.
		Dead band mode <input type="checkbox"/> = <input checked="" type="checkbox"/> =Mode 1 Mode 2	Mode 1: When calculating the reactive current, the value of the dead band is not subtracted from the amount of voltage change. As such, formula (2) applies to overvoltage and undervoltage incidents. Mode 2: When calculating the reactive current, the value of the dead band is subtracted from the amount of voltage change. For overvoltage and undervoltage events, formula (4) therefore applies: $I_b = (\Delta U_1 - t_b) * k * I_N$
		Minimum operating voltage  45 - 125.0 [% Unom] & Maximum operating voltage  45 - 125.0 [% Unom]	Dynamic grid support via fast feeding of residual current is activated on voltage events with at least one phase/phase or phase/neutral conductor voltage outside the configured normal operating voltage range. Dynamic grid support via fast feeding of residual current is deactivated when the voltage returns to the normal operating voltage range.
		Reactive current limitation  0 - 100 [% I _{max}]	The reactive power component of the fast feeding of residual current is limited to permit a defined proportion of active power components.
		Minimum support time  1000 - 15000 ms	If due to a voltage jump in accordance with formula (1) and the configured dead band is activated, the dynamic grid support is deactivated via fast feeding of residual current after the minimum support time elapses.

10.4 Other grid-supporting functions that are effective in the case of active power

10.4.1 Permanent power gradient limitation

The maximum active and apparent power to be installed for a generation plant is agreed between the grid operator and plant operator. The device capacity of a plant can be set to the exact agreed value using the S_{lim} and P_{lim} settings. To ensure that the load on the devices in the plant is uniform, we recommend distributing the performance reduction evenly across all devices.

Some grid connection rules insist that the agreed reactive power be supplied from every operating point of the plant without a reduction in the actual active power. Considering the fact that all KACO TL3 inverters have a semi-circular P-Q operating range, a reduction in the active power is, however, required during operation at maximum active power because an apparent power reserve is not available. By adjusting P_{lim} , the maximum active power can be restricted in order to establish an apparent power reserve and ensure that the agreed reactive power can be delivered from any active power operating point. The graphic [See figure 54 ▶ Page 69] shows the appropriate P-Q operating range with a required example active power of 48% of the maximum apparent power of the plant or 43% of the maximum active power of the plant.

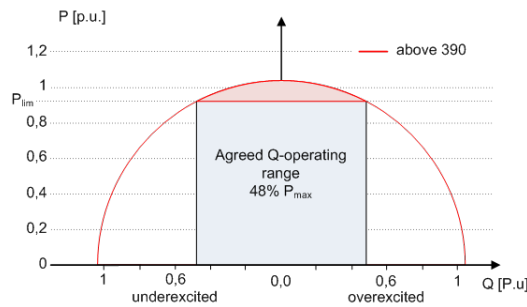

Fig. 54: P-Q operating range with limited active power ($Q_{max}=S_{max}\neq P_{max}$) for PV inverters

The power reduction parameters can be adjusted in SunSpec model DID123. During this process, you should also check whether internal and/or external power reduction is active.

Internal power limitation	Parameters for external power limitation	Parameters for power limitation
Status = active	Status = active	Parameters in SunSpec model 123:
Maximum apparent power S_{lim} = 100000 VA		"WMaxLimPct" = 50% P_{lim} (approx. 40000 W)
Maximum active power P_{lim} = 80% (approx. 80000 W)	AC fallback active power P_{fb} = 75% P_{lim} (approx. 60000 W)	"WMaxLimPct_RvrtTms" = 60 s
	PT1 settling time = 1 s	"WMacLimPct_RmpTms" = 2 s
		"WMaxLim_Ena" = 1

Tab. 6: Sample parameters for power limitation

If the ramp time "WMaxLimPct_RvrtTms" in the SunSpec model is specified as 0 s, then the internal output gradient is used. Otherwise, the set value will be used.

Irrespective of the communication protocol used, the settling time "WMaxLim_Ena" is used in order to transfer the new power value. Otherwise, the internally configured value will be used.

The additional ramp time "WMaxLimPct_RmpTms" specifies the jump time from a power value to the new power value.

The following formulae are used to calculate the gradient $S_{lim/min}$:

$$\text{GradientWattPerMin} = \frac{\left(\frac{WMaxLimPct}{100} \times P_{lim} - P_{actual}\right)}{WMaxLimPct_{RmpTms}} \times 60 \times \frac{100}{S_{lim}}$$

$$\text{GradientWattPerMin} = \frac{\left(\frac{50\%}{100} \times 40000 \text{ W} - 60000 \text{ W}\right)}{2 \text{ s}} \times 60 \times \frac{100}{100000 \text{ VA}}$$

GradientWattPerMin = -600 % Slim /min

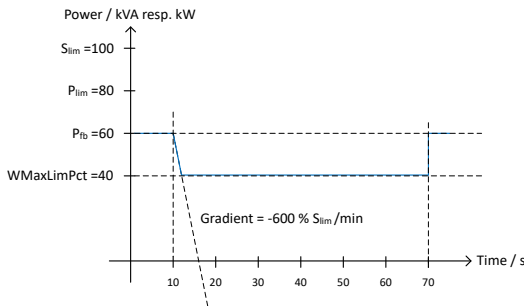

Fig. 55: Power gradient according to sample parameters and calculation

The following formulae are used to calculate the Q filter parameter and cos φ gradient:

$$\text{GradientVArPerMin} = \frac{\left(\frac{\text{VArMaxPct}}{100} \times S_{lim} - Q_{actual}\right)}{\text{VArPct_RmpTms}} \times 60 \times \frac{100}{S_{lim}}$$

Fig. 56: Formula for calculating the Q filter parameter

$$\text{GradientVArPerMin} = \frac{\left(\frac{\text{VArMaxPct}}{100} \times S_{lim} - Q_{actual}\right)}{\text{OutPFSet_RmpTms}} \times 60 \times \frac{100}{S_{lim}}$$

Fig. 57: Formula for calculating the cos φ gradient (internal power gradient)

10.4.1.1 Parameters for permanent power limitation

Country-spec. Settings	Menu Display/Setting level	Action in this menu/meaning
	Power limitation	Activate or disable the power limitation.
	Check activation	
	Maximum apparent power 1000 – S _{max} [VA]	The apparent power is limited globally to the configured value in VA. As soon as S _{lim} has been configured, all of the active and reactive power control values will use S _{lim} as 100% instead of S _{max} .
	Maximum active power 1 – 100 [% S _{lim}]	Active power is limited globally to the configured value in % S _{lim} or S _{max} .



10.4.2 Soft start up / power ramp-up limiting

A soft start-up function is available to prevent the grid from being negatively impacted by a sudden increase in feed-in power from the inverters.

When the inverter is activated or switched on, the increase in power is restricted by the set gradient. It is possible to configure whether the soft start-up should occur every time the device is switched on, only upon initial start-up each day or only upon start-up after the device has been switched off by grid protection. Due primarily to the fact that there is the risk that many plants could increase their power levels simultaneously after they have been switched off by grid protection, a soft start-up is usually only required for start-up after a device has been switched off by grid protection.

The soft start up is implemented by an absolute power limitation that increases with a continuous gradient up to the maximum power. The actual power of the inverter may vary freely below this limit due to a possible fluctuation in the available power or the target value, but at no time increases above the absolute power limit.

10.4.2.1 Parameter for power ramp

Power ramp		 NOTE: The power ramp allows a moderate increase of the Performance possible
Gradient	 1 – 600 [% / min]	Gradient of power limit. The maximum power limit increase to 100% of nominal power with the gradient specified.
After every connect		Soft start ramp up is activated for every connection of the inverter to the grid
After first connect		Soft start ramp up is activated for the first connection of the inverter to the grid on a particular day or after complete reboot of the inverter (AC and DC disconnected)
After grid error		Soft start ramp up is activated for connection of the inverter to the grid after trip of the internal interface protection or via the external grid protection port (Powador-protect)

10.5 Advanced islanding detection

Due to decentralized generation, there is the possibility that a deactivated part of the grid will remain live in an unintended island due to the balance of load and generation in this part of the grid. The detection of unintended island formation is an important function of decentralized generating units and is related to the prevention of damage to equipment as well as safety of personnel.

Depending on the structure and the operation of the distribution grid several dangers exist:

- In case of maintenance work in a distribution grid, personnel may be placed in danger if the deactivated part of the grid remains live as an island. This is especially the case if not all safety rules are followed.
- If fast auto-reclosure is used in a distribution grid and the deactivated part of the grid remains live as an island, reclosure will likely happen during phase displacement which might cause damage to rotating machinery on the grid.
- In the event of a fault in a medium voltage grid, the faulty part of the grid is disconnected. If the fault has a significant resistance, the deactivated part of a medium-voltage grid remains live as an island. Depending on the type of fault, but explicitly in case of a fault in the transformer, dangerous medium voltage might be accessible or even present in low-voltage appliances.

Especially for the last example very fast disconnection of the generating units to cause collapse of the forming island is necessary. At the same time any island formation detection method may cause false tripping. The industry is therefore in constant research to develop methods that are fast and reliable and at the same time reliably prevent false tripping.

Enhanced island detection method

KACO new energy's advanced islanding detection uses a reliable islanding detection strategy based on the characteristic differences between an interconnected grid and an islanded grid, thus ensuring reliable fast detection and prevention of false tripping.

An interconnected grid is dominated by rotating machinery, as a consequence frequency is proportional to active power balance and voltage is proportional to reactive power balance. In contrast an islanded grid behaves like a resonant circuit, as a consequence frequency is proportional to reactive power balance and voltage is proportional to active power balance. The active enhanced island detection method detects this difference by monitoring the behaviour of the grid. The enhanced island detection is monitoring the natural fluctuation of the grid frequency and injects a minimal reactive power proportional to the rate of change of frequency. In the moment an island is formed, the connected power grid closes a positive feedback loop which allows the inverter to detect the changed situation and to disconnect. In case of formation of an island, the inverter disconnects within some 100 ms, well below 1000 ms.

- The number of parallel inverters does not affect the reliability of this function.
- This method also guarantees the minimisation of effects on the distribution grid.
- In normal operation no effects on harmonic content, flicker and grid stability are detected.

This detection method is combined with a two stage passive rate of change of frequency (ROCOF) observation. If the ROCOF of the grid exceeds the configured disconnection threshold of stage 1 for the configured disconnection time, the device switches to zero current mode. If the ROCOF of the grid exceeds the configured disconnection threshold of stage 2 for the configured disconnection time, the device switches off. In case of an island, this will shut down the island instantaneously. If the grid stabilizes, what might be the case if the ROCOF event was due to a short disturbance in the power grid, the inverter will resume normal operation. With stage 1 active, the device has switched to zero current mode and will recommence feed-in after only 100 ms. With stage 2 active, the device has switched off and the set reconnection conditions shall apply.

10.6 Behavior in case of communication failure



NOTE

Communication in the event of a communication timeout

In the event of a communication timeout, the value is queried in the timeout parameter for the reactive power shift factor $\cos \varphi$ [See section 10.1.3 ▶ Page 58], reactive power [See section 10.1.3 ▶ Page 58] and active power [See section 10.2.2 ▶ Page 61]. If all values for the timeout are set to 0 seconds, the current functions are retained without a fault message being issued.

11 Maintenance and troubleshooting

11.1 Visual inspection

Inspect the product and cables for visible external damage and note the operating status display, where applicable. In the event of damage, notify your installation engineer. Repairs may only be carried out by authorised electricians.



⚠ DANGER

Risk of fatal injury due to contact voltages!

Removing the plug connections before disconnecting the device from the PV generator may lead to injuries and damage the device.

1. During installation: Electrically disconnect the DC positive and DC negative from the protective earth (PE).
2. Disconnect the device from the PV generator using the integrated DC isolator switch.
3. Remove the plug connector.



⚠ DANGER

Dangerous voltage due to two operating voltages

Severe injuries or death may occur if the cables and/or terminals/busbars in the device are touched. The discharge time of the capacitors is up to 5 minutes.



1. Only appropriately qualified electricians authorised by the mains supply network operator are permitted to open and maintain the device.
2. Before opening the device: Disconnect the AC and DC sides and wait at least 5 minutes.



NOTE

There are components in the housing of the device which may only be repaired by the customer service team.

1. Do not attempt to repair faults that are not described here (in the chapter on troubleshooting and fault rectification). Contact our Customer Service department. Only perform the maintenance work that is described here.
2. Log each maintenance activity in the "Service" menu item: "Service Log" (exception: "User" interface) [See section 9.4.2 ▶ Page 47]
3. The device should be checked for proper operation by a qualified electrician at regular intervals and if you experience problems, you should always contact the system manufacturer's Service department.

11.2 Cleaning

11.2.1 Cleaning the housing



⚠ DANGER

Danger of death due to penetrating fluid

Serious injuries or death can result if moisture enters the system.

1. Only use completely dry objects to clean the device.
2. The device should only be cleaned from the outside.

⚠ CAUTION

Damage to the housing parts when using cleaning agents!

1. If the device is contaminated, only clean the housing, cooling fins, housing cover, display and the LEDs with water and a cloth.

⚠ CAUTION

Risk of damage to the device during cleaning!

1. Do not use compressed air or high-pressure cleaners.
2. Use a vacuum cleaner or a soft brush to remove dust from the fan cover and from the top of the device on a regular basis.
3. Remove dust from the ventilation inlets if necessary.

11.2.2 Cleaning the heat sink

⚠ WARNING



Risk of burns from hot surface.

Heat sinks become very hot when in operation.

1. Never touch the heat sinks after commissioning the device.
2. Allow the heat sinks at least 10 minutes to cool down before cleaning.

NOTE



Refer to our service and guarantee conditions on our homepage.

- ✓ The cleaning intervals must be adapted to match the ambient conditions of the installation location.
1. In sandy environments, we recommend cleaning the heat sinks and fans every quarter.

⌚ If the heat sink is heavily soiled, we recommend that you dismount the fan temporarily.

⌚ Switch off the device and secure it against restart.

1. Clean the space between the heat sink with a suitable brush.

• **NOTE: Do not use any aggressive cleaning agents and ensure that no other components come into contact with fluids.**

⇒ Cleaning completed – if necessary, remount the fans.

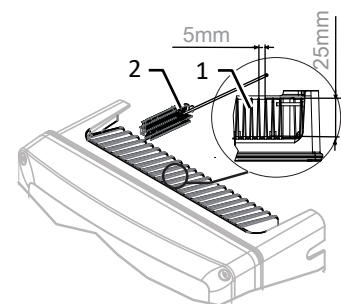

Fig. 58: Clean the cooling fins

- 1 Heat sink / space between heat sink
- 2 Brush (max. wire diameter 3 mm)

11.3 Replacing the fan

The device is equipped with an axial fan. This is located in the upper section of the side panel of the housing. Replace the fan in the following circumstances:

- Heavy soiling
 - A fault
- Device switched off on integrated DC isolator switch.
 - Wait until the fan is no longer turning.
 - 1. Release the protective cover and ventilation grille by unscrewing the 4 screws [X_{T_15}].
 - 2. Carefully take down the protective cover and fan and remove the power supply connector plug from the fan.
- ⇒ Replace or clean the defective fan.

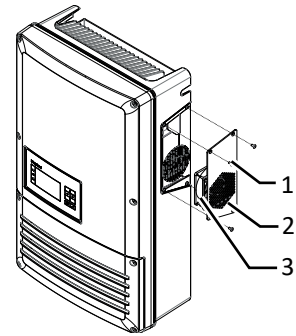

Fig. 59: Removing the cover and fan

- 1 Protective cover
- 2 Air inlet grilles
- 3 Fan with connector plug

Dismounting the fan

- You have removed the cover and fan.
 - **NOTE: Make a note of the installation position of the fan before you dismount it!**
 - 1. Set the protective cover down on a flat surface and release the fan by unscrewing the 4 screws [X_{T_10}].
 - 2. Remove the fan.
- ⇒ Insert the replacement fan.

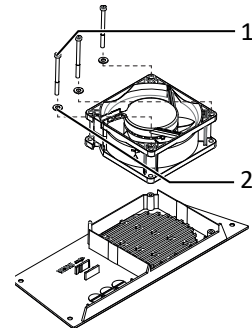



Fig. 60: Installing the replacement fan

- 1 Screws for mounting
- 2 Lock washer

Inserting the fan

- You have removed the defective fan.
 - **NOTE: The replacement fan should be identical in construction and type.**
 - 1. Hook the replacement fan onto the intended fastening point on the protective cover.
 - 2. Mount the fan by tightening the 4 screws in a diagonally opposite sequence [X_{T_10} /  1.5 Nm].
 - 3. Lift the protective cover up to the mounting position and connect up the power supply connector plug to the fan.
 - 4. Secure the protective cover using the 4 screws [X_{T_15} /  2.5 Nm]
- ⇒ Fan replaced. Restart the device to check that the fan is functioning correctly.

11.4 Shutting down for maintenance / troubleshooting



DANGER

Lethal voltages are still present in the connections and cables of the device even after the device has been switched off and disconnected!

Severe injuries or death may occur if the cables and/or terminals/busbars in the device are touched.

Only appropriately qualified electricians authorised by the mains supply network operator are permitted to open and maintain the device.

1. › Comply with all safety regulations and current technical connection specifications of the responsible power supply company.

NOTE: Shutdown sequence

1. Switch off the grid voltage by turning off the external circuit breakers.
 2. Disconnect the DC side using the integrated DC isolator switch.
 - **DANGER! The DC cables are still live!**
- ⇒ After shutdown, wait 5 minutes before opening the device.

11.5 Overvoltage protection



DANGER

Risk of fire if the overvoltage module is disconnected under load!

The connection terminals and fuse holder can be destroyed by arcing if disconnected or if the modules are removed.

✓ Switch-off sequence:

1. Switch off the grid voltage by turning off the external circuit breakers.
2. Switch off the PV generator using the DC isolator switch.
3. **The DC cables are still live!**
4. Check that there is no current in any of the DC cables using a clip-on ammeter.
5. Only open the fuse holder once you have established that there is no current in the DC cables.
6. Ensure that there is no voltage present on the grid connection terminals.

Checking the overvoltage protection modules

- ⌚ The shutdown sequence in the preceding warning has been carried out.
 - ⌚ Lower housing cover open.
 - ⌚ Base monitoring must be activated via the menu SPD monitoring.
 1. Check individual modules using the status display.
 - **NOTE: Faulty modules report a colour-coded status.**
- ⇒ Testing finished, replace any faulty modules.

Replacing the overvoltage protection modules

- ⌚ Ensure there is no AC/DC voltage present.
 - ⌚ **NOTE: Modules can be ordered from the KACO customer service team.**
 1. Unlock faulty DC modules via the upper locking latches using a screwdriver.
 2. Remove faulty modules from the base.
 3. Transfer the coding in the base to the new module of the same type.
 4. Insert modules into the base.
- ⇒ Surge protection device is fully equipped. Close the housing cover and switch on the device ([See section 8 ▶ Page 32]).

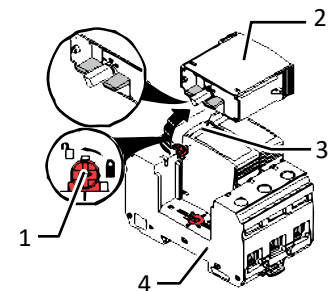

Fig. 61: DC overvoltage protection

- 1 Lock
- 2 Overvoltage module
- 3 Status indicator
- 4 Base

11.6 Faults

11.6.1 Procedure



! DANGER

Lethal voltages are still present in the connections and cables of the device even after the device has been switched off and disconnected!

Severe injuries or death may occur if the cables and/or terminals/busbars in the device are touched.

1. If a fault occurs, notify an appropriately authorized and qualified electrician or KACO new energy GmbH Service.
2. The operator can only carry out actions marked with a B.



NOTE

In case of power failure, wait for the system to automatically restart. Notify your electrician if there is an extended power failure.

11.6.2 Rectifying a fault

Fault	Possible cause	Explanation/remedy	By
The display is blank and the LEDs do not light up	Grid voltage not available	› Check whether the DC and AC voltages are within the permitted limits (see Technical Data)	E
		› Notify KACO Service.	E
The device stops feeding into the grid shortly after being switched on, even though there is sunlight present.	Faulty grid separation relay in the device.	If the grid separation relay is defective, the device will recognise this error during the self-test.	K
		› Ensure that there is sufficient PV generator power.	E
		› If the grid separation relay is defective, have it replaced by KACO Service.	E
		› Notify KACO Service.	E
Device is active but is not feeding into the grid. The display indicates a grid failure.	Grid-feed is interrupted due to a grid fault.	Due to a grid fault (over/undervoltage, over/underfrequency), the device stopped the feed-in process and disconnected from the grid for safety reasons.	
		› Change the grid parameters within the permitted operating limits (see the "Start-Up" section).	E
The grid fuse trips.	The grid fuse capacity is too low.	In case of a high level of solar radiation, the inverter exceeds its rated current for a short period, depending on the PV generator.	
		Select the capacity of the device's backup fuse to be somewhat higher than the maximum feed-in current (see the "Installation" section).	E
		› Contact the grid operator if the grid failure continues to occur.	E
The grid fuse trips.	Hardware damage on the device.	If the grid fuse trips immediately when the device goes into feed-in mode (after the start-up period is complete), the device's hardware is probably damaged.	
		› Contact KACO Service to test the hardware.	E
The device is displaying an impossible daily peak value.	Faults in the grid.	The device continues to operate as normal without losses to the yield, even when an erroneous daily peak value is displayed. The value is reset overnight.	
		To reset the value immediately, switch the device off by disconnecting it from the grid and switching off the DC, then switch it back on.	E

Fault	Possible cause	Explanation/remedy	By
Daily yields do not correspond to the yields on the feed-in meter.	Tolerances of the measuring elements in the device.	The measuring elements of the device have been selected to ensure maximum yields. Due to these tolerances, the daily yields shown may deviate from the values on the feed-in meter by up to 15%. › No action.	E
Device is active but is not feeding into the grid. Display: "Waiting for feed-in"	Generator voltage too low; grid voltage or PV generator voltage unstable.	The PV generator voltage or power is not sufficient for feed-in (solar radiation is too low). The inverter checks the grid parameters before the feed-in process begins. The length of time it takes to switch back on again differs from country to country, depending on applicable standards and regulations, and may be several minutes. The starting voltage may have been set incorrectly. › Adjust starting voltage in the Parameter menu.	E
Noise emission from the device.	Particular ambient conditions.	When there are certain ambient conditions, the devices may emit audible noises. Grid interference or grid failure caused by particular loads (motors, machines, etc.) which are either connected to the same point on the grid or located in the vicinity of the device. Under particular grid conditions, resonances may form between the device's input filter and the grid; these may be audible even when the device is switched off. These noise emissions do not affect the operation of the device. They do not lead to loss of performance, failure, damage or to a shortening of the device's service life. People with very sensitive hearing (particularly children) are able to hear the high-frequency hum caused by the device's operating frequency of approximately 17 kHz. › No action	
In spite of high radiation levels, the inverter does not feed the maximum power into the grid.	Particular ambient conditions.	Because the temperatures inside the device are too high, the device reduces its power to prevent damage to the device. Note the technical data. Ensure that the convection cooling is not impeded from the exterior. Do not cover the cooling fins. › Ensure sufficient cooling of the device.	B
		Remove any foreign bodies which are present on the unit.	B
		› Clean the cooling fins	E
	DC fuse defective	A generator string is disconnected from the device owing to a faulty fuse. Check why it has tripped by measuring all DC strings using a clip-on ammeter. If there is no current flow in a string, the associated DC fuse is faulty. Check the no-load voltage and dimensioning of the PV generator. Replace any damaged modules. › Replace the PV fuse with a fuse of the same size and type.	B, E

Tab. 7: Troubleshooting

B = Operator's responsibility ; E = The indicated work may only be carried out by an authorised electrician. ; K = The indicated work may only be carried out by a service employee of KACO new energy GmbH!

11.7 Fault messages













Many fault signals indicate a fault in the grid. They are not operational faults of the device. The triggering levels are defined in standards, e.g. VDE0126-1-1. The device shuts down if the values exceed or fall below the approved levels.



Fault LED (red)	Status	Explanation	LED
	FS (fault status)	– Fault signal relay has been tripped. – Feed-in was ended due to a fault.	To:

















Fault LED (red)	Status	Explanation	LED
	OS (operating status)	<ul style="list-style-type: none"> – The fault relay releases again. – The device feeds back into the grid again after a country-specific time period. 	Off





















11.8 Troubleshooting























The following table lists the possible status and fault messages, the ProLog© status messages that the device can display by means of the LC display / web interface and the LEDs.















No.	Grid LED	LED	Display	Status description	Action	Pers.
1			Waiting for feed-in	The start voltage (pre-)set in the device is higher than the actual voltage. The device waits for the solar voltage to exceed an adjustable value and for a stable grid.	Check whether the start voltage was set too high in the menu.	B
2			Insufficient generator voltage / insufficient battery voltage	Insufficient generator voltage and power, status before the transition to night shutdown.	Insufficient DC voltage or voltage fails under load (insufficient DC power) a) Compare the voltage measured with the no-load voltage expected. b) Check if the DC isolator switch is switched off c) Check whether a D	B
3			Constant volt. control	No MPP control occurs. If sunlight conditions are good, the message indicates that there is an error in configuration. Constant volt. control When feed-in begins, a constant generator voltage is fed in for a short period (75% of the no-load voltage measured)	The constant voltage can be enabled/disabled in the service menu.	-
8			Self test in progress	Checks the shutdown of the power electronics as well as the grid relay before feed-in mode.	If the device remains in this status continuously despite adequate DC voltage, this indicates a device fault	E
10			Temperature in unit too high	Possible causes: ambient temperature too high, fan covered, device fault.	Cool off the area around the inverter. Uncover the fans. Contact a qualified electrician!	B E
17			"Powador-protect disconnection" or "External grid protection shutdown"	The activated grid and system protection has been tripped.	Wait for reactivation. Notify your authorized electrician if the fault occurs repeatedly!	E





























No.	Grid LED	LED	Display	Status description	Action	Pers.
18			Resid. current shutdown	AFI shutdown: Residual current is too high, the integrated AC/DC-sensitive residual current device has registered an unduly high leakage current to the PE.	Check PE cabling; the cause is generally faulty cabling to earth. Often occurs during rainfall in the case of faulty cabling. Measure the insulation resistance of the system.	E
19			Generator insulation fault	There is an insulation fault on the PV generator. The feed-in was interrupted.	Measurement of the insulation resistance using suitable measuring equipment by trained personnel. Possible cause: 1. Insulation fault present on DC side. 2. Defects in the DC installation 3. Inappropriate threshold value set in the parameters menu. Limit value for insulation resistance can be set to min. 40 kOhm. With a setting below 200 kOhm, an AFI of type B must be used with a required external AFI! An insulation resistance <200 kOhm should not occur with crystalline modules. With thin layer modules, this can occur in extreme cases. Default setting value is 200 kOhm.	E
20			Active ramp limitation	Internal ramp limiting, e.g.: "Ramp Up" 10 %/Min • After an overvoltage has been detected, for example, the device limits its output and slowly ramps up again (RampUp).	The "Feed-in" LED flashes for the duration of the device start-up.	-
30			Voltage trans. fault	Current and voltage measurement in the device are not plausible.	Switch off the device entirely (switch off AC + DC for min. 5 minutes), if the fault occurs again, contact the service department	B























No.	Grid LED	LED	Display	Status description	Action	Pers
31			AFI module fault	Current offset during automatic offset adjustment too great.	Disconnect the device from the AC and DC supply. Switch it back on after several minutes. If this does not resolve the issue, notify your authorized electrician	B E
32			Self test error	Error during self-test: An error occurred during the relay test	- does the N cable have a smaller cross-section? - N requires the same cross-section as the outer conductors - measure the difference in potential between N and PE -- > greater than 5 V could cause problems. Then there is a problem with the system rather than a device fault	E
33			DC feed-in error	The DC feed-in has exceeded the permitted value. This DC feed-in can be caused in the device by grid conditions and may not necessarily indicate a fault.	Notify your authorized electrician if the fault occurs several times.	E
34			Internal communication error	A communication error has occurred in the internal data transmission.	Contact a qualified electrician! Check the data cable.	E
35			Protection shutdown SW	Protective shutdown of the software (AC overvoltage, AC overcurrent, DC link overvoltage, DC overcurrent, DC overtemperature).	Not an error! Grid-related shutdown, the grid connects again automatically.	-
36			Protection shutdown HW	Group error for all trip zone shutdowns, generally the precise shutdown reason appears first, followed by this group error. Cause: Saturation monitoring of the AC IGBTs or AC overcurrent. Protective shutdown when critical limits are exceeded, hardware.	Not an error! Grid-related shutdown, the grid connects again automatically.	-
37			Unknown hardware	No valid version of the power unit was detected. Incorrect hardware installed.	Disconnect the device from the AC and DC supply. Switch it back on after 5 minutes. If this does not resolve the issue, notify your authorised electrician	B E
38			Error: Generator Voltage too high Error: Battery overvoltage	The voltage of the DC generator is too high. The PV generator is configured incorrectly.	Contact a qualified electrician!	E

No.	Grid LED	LED	Display	Status description	Action	Pers
41			Grid failure undervoltage L1	Voltage on Lx below the set limit value. The limit value is country-dependent.	Check AC voltage on E inverter terminal. Check AC wiring. Check setting values in the parameters menu. Has everything been set correctly, is the voltage within the limit values and is voltage present? If this is not the case, then there is a fault in the device.	.
42			Grid failure overvoltage L1	Voltage on Lx above the set limit value. The limit value is country-dependent.	Check AC voltage at connection terminals. Check setting values in the parameters menu. Contact the service department if the error persists	E
43			Grid failure undervoltage L2	see description in the event of an error 41	see action in the event of an error 41	E
44			Grid failure overvoltage L2	see description in the event of an error 42	see action in the event of a error 42	E
45			Grid failure undervoltage L3	see description in the event of an error 41	see action in the event of an error 41	E
46			Grid failure overvoltage L3	see description in the event of an error 42	see action in the event of a error 42	E
47			Grid failure phase-to-phase voltage	The measured phase-to-phase voltage is outside of the tolerance limits.	Check software version (possible cancellation during upload) Notify KACO Service!	B/K
48			Grid failure underfrequency	Measured value for grid frequency is outside the permissible limit. Limit is country-dependent. Grid frequency below the minimum permissible grid frequency set	Check setting values in the parameters menu. Fault can be caused by a poor connection on the AC side. Check connection terminals from the device to the grid connection.	E
49			Grid failure overfrequency	Measured value for grid frequency is outside the permissible limit. Limit is country-dependent. Grid frequency below the minimum permissible grid frequency set	see action in the event of an error 48	E
50			Grid failure: average voltage	The grid voltage measurement according to EN 50160 has exceeded the maximum permitted limit value. This fault may be grid-related.	Contact a qualified electrician!	E











No.	Grid LED	LED	Display	Status description	Action	Pers.
57			Waiting for reactivation	Waiting time of the device following an error.	The devices switches on after a country-specific waiting period.	-
58			Control board overtemp.	The temperature inside the device was too high. The device shuts down to avoid hardware damage.	Ensure sufficient ventilation.	E
59			Self test error	A fault occurred during a self-test.	Contact a qualified electrician!	E
60			Generator voltage too high Battery voltage too high	The inverter does not begin feeding into the grid until the PV voltage falls below a specified value.	-	-
61			External limit x%	The grid operator has activated the external PowerControl limit. The inverter limits the power.	-	-
63			Frequency-dependent power change	The feed-in power is changed linearly over a certain frequency value. This requirement is country-dependent. Required response. No indication on display (behaves in the same way as normal feed-in mode status 4, therefore no flashing "Feed-in" LED) Can be viewed in service log files and via proLOG/portal. When certain country settings are activated, the frequency-dependent power change is activated.	Normative requirement	-
64			Output current limitation	Output current limiting: The AC current is limited once the specified maximum value has been reached.	-	-
70			Fan 1 error	The fan is malfunctioning.	Replace defective fan. See Maintenance and troubleshooting chapter.	E
73			Standalone grid err.	Standalone mode was detected.	Is the grid still present with all three phases (fuses tripped)?	E
74			External idle power requirement	The grid operator limits the feed-in power of the device via the transmitted reactive power factor.	Not an inverter error! This is a requirement based on standards	-
75			Self test in progress	No fault message, only a status. Pre-charging of DC link in progress. Entire self-test sequence documented in S7.	If, despite adequate sunlight conditions, the device remains in this status permanently, then there is probably a fault -> arrange for a service to be carried out	-



No.	Grid LED	LED	Display	Status description	Action	Pers
78			Resid. current shutdown (AFI)	AFI shutdown: The measured residual current has exceeded the max. permissible residual current for the device series.	If the fault occurs, in B particular in the event of precipitation, or high air humidity, this indicates an increased discharge current -> check cabling in the system and module insulation resistance. An internal device fault is not likely - no such incidents thus far.	-
79			Insulation measurement	PV generator's insulation is being measured	-	-
80			Insulation meas. not possible	The insulation measurement cannot be performed because the generator voltage is too volatile.	If a fault message appears continuously, arrange for a service to take place.	B
81			Protection shutdown grid volt. L1	Overvoltage has been detected on a conductor. An internal protective mechanism has disconnected the device to protect it against damage.	Fault may be in a grid voltage measurement which was outside the permissible range Check the AC-side wiring (e.g. peak voltage due to inductance capacity of a transformer)	E
82			Protection shutdown grid volt. L2	See description in the event of an error 81	See action in the event of an error 81	E
83			Protection shutdown grid volt. L3	See description in the event of an error 81	See action in the event of an error 81	E
84			Protection shutdown under-volt. DC link	If the min. value of the DC link voltage is not reached, this will be displayed. DC link voltage is too low. Protection shutdown	Poll the wiring on the AC side (inductance of a transformer, length of cable between transformer and inverter). There have been no incidents of internal device faults. The cross-section of the N-conductor must not be reduced. Development experience: Oscillation usually only occurs at higher power levels	E

No.	Grid LED	LED	Display	Status description	Action	Pers.
85			Protective shutdown over-volt. DC link	1. If the max. value of the DC link voltage is exceeded, this will be displayed. 2. Protection shutdown by Piccolo (DC-DSP) After a shutdown, there is a reconnection after 3 seconds. Protective shutdown overvolt. DC link	Poll the wiring on the AC side (inductance of a transformer, length of cable between transformer and inverter). There have been no incidents of internal device faults. The cross-section of the N-conductor must not be reduced. Development experience: Oscillation usually only occurs at higher power levels	E
86			Protect. shutdown DC link asymmetry	Overvoltage has been found in the DC link. An internal protective mechanism has disconnected the device to protect it against damage.	In case of repeated occurrence: Contact a qualified electrician!	E
87			Protection shutdown over-current L1	A current that has been found on a conductor is too high. An internal protective mechanism has disconnected the device to protect it against damage.	In case of repeated occurrence: Contact a qualified electrician!	E
88			Protection shutdown over-current L2	See description in the event of an error 87	See action in the event of an error 87	E
89			Protection shutdown over-current L3	See description in the event of an error 87	See action in the event of an error 87	E
90			Protect. shutdown drop 5V	-	-	-
91			Protective shutdown drop 2.5 V	Protective shutdown because internal 2.5V reference voltage outside the permissible range.	Device error detected	-
92			Protective shutdown drop 1.5V	Protective shutdown because internal 1.5V reference voltage outside the permissible range.	Device error detected	-
93			Self test error buffer 1	Buffer test error during self-test. Automatic re-start after 3 minutes.	Notify authorised electrician / KACO Service!	E/K
94			Self test error buffer 2	See description in the event of an error 93	See action in the event of an error 93	E/K
95			Self test error relay 1	The power section is defective.	Notify KACO Service!	K
96			Self test error relay 2	See description in the event of an error 95	See action in the event of an error 95	K
97			Protection shutdown over-current HW	Too much power has been fed into the grid. Complete disconnection of the device.	Notify authorised electrician / KACO Service!	E/K
98			Protect. shutdown HW gate driver	An internal protective mechanism has disconnected the device to protect it against damage. Complete disconnection of the device.	Notify authorised electrician / KACO Service!	E/K

No.	Grid LED	LED	Display	Status description	Action	Pers.
99			Protect. shutdown HW buffer free	An internal protective mechanism has disconnected the device to protect it against damage. Complete disconnection of the device.	Notify authorised electrician / KACO Service!	E/K
101			Temperature plausibility error	The device has shut down because of implausible internal measured values.	Notify KACO Service!	K
103			Plausibility fault DC link	The device has shut down because of implausible internal measured values.	Notify KACO Service!	K
105			Plausibility fault relay	The device has shut down because of implausible internal measured values.	Switch off the device entirely (switch off AC + DC for min. 5 minutes), if the fault occurs again, there is a device fault	K
106			Plausibility error DCDC converter	Offset of DC current sensors >+-5A (offset calculated prior to feed-in) explanation: if the DC current on the DC side had to be adjusted by more than 5A, then this error is output	- Offset is only calculated once a day prior to feed-in - error persists - inverter goes into overnight shutdown -> error is reset	K
108			Grid failure overvoltage L1	Shutdown because the grid voltage on phase L1 is outside the upper limit value (2-stage inspection). 108...113 quick shutdowns	Check grid voltage. Check set values in the parameter menu.	E
109			Grid failure overvoltage L2	See description in the event of a fault 108	See action in the event of an error 108	E
110			Grid failure overvoltage L3	See description in the event of a fault 108	See action in the event of an error 108	E
111			Grid failure undervoltage L1	Grid failure undervoltage L1	Check grid voltage. Check set values in the parameter menu.	E
112			Grid failure undervoltage L2	Critical undervoltage L2	Check grid voltage. Check set values in the parameter menu.	E
113			Grid failure undervoltage L3	Critical undervoltage L3	Check grid voltage. Check set values in the parameter menu.	E

No.	Grid LED	LED	Display	Status description	Action	Pers.
131			Arc detected on DC1	<p>An arc is a gas discharge between two electrodes with strong heat development. It can lead to fire and is caused by faulty electrical connections or voltage flashover due to faulty insulation. The arc monitoring on the DC side has detected an arc spectrum on said tracker. An arc is likely, but it could also have been triggered by other external influences that produce a similar interference spectrum. A review of the system is to be carried out. The error must be reset manually. A corresponding entry appears in the installer menu. Arc detected on DC1 After max. 800ms, the feed-in operation is terminated and the inverter is disconnected from the mains. These events will be saved. Only after the fault has been acknowledged by the installer can the unit be switched back to feed-in operation.</p>	<p>Possible Error: Faulty plug connections or junction boxes (loose contacts), faulty cables (animal bite), defects in the module itself. Check cables, Check whether the open-circuit voltage of the individual strings is OK in order to isolate the fault on the individual string. If no error is found, analyse possible sources of interference: If the DC cables are routed together with other circuits, coupling from other electrical devices may have occurred. Is there a connection between the tripping and the operation of other electrical devices? Kaco service technicians can pull a data set on USB that can be used to analyse the interference spectrum. The record is automatically included when the service logs are deducted.</p>	B E
132			Arc detected on DC2	See fault 131	See fault 131	-
133			Arc detected on DC3	See fault 131	See fault 131	-
134			AFCI power supply critical	<p>Self-test fault: The supply voltage of the AFCI is outside the tolerance. AFCI power supply critical The two supply voltages (5V & 3.3V) are monitored AFCI module defective.</p>	Is the RJ45 cable plugged in correctly?	-
135			Internal AFCI ADC failed	-	-	-
157			Control board watchdog	Control board watchdog triggered	Notify the service department.	E

No.	Grid LED	LED	Display	Status description	Action	Pers.
181			Insulation error, centre	The insulation error is located close to the centre of a PV string. The area covers +-15% of the half of the modules based on the total number of modules. When the insulation resistance is distributed equally across the entire string, this message is also generated when the calculated insulation resistance falls below the set value. Insulation error close to the centre of the PV string (area covering +-15% of the half of the string)	Insulation errors must be rectified in order to operate the system safely and reliably.	B
182			Insulation error, minus	The insulation error is located between the centre of a string and the minus terminal on the inverter. If the insulation error is located very close to the minus inverter terminal, then the error occurs even if the insulation error <150 kOhm and is above the set value. Insulation error on the minus terminal side of the PV string.	See action in the event of an error 181	B
183			Insulation error, plus	The insulation error is located between the centre of a string and the plus terminal on the device. If the insulation error is located very close to the plus inverter terminal, then the error occurs even if the insulation error <150 kOhm and is above the set value. Insulation error on the plus terminal side of the PV string.	See action in the event of an error 181	B
203			Protection shutdown grid volt. L1	Protection shutdown grid voltage (effective value) L1	Incorrect grid voltage measurement that is outside the permissible range. Check the AC-side wiring (e.g. increased voltage due to inductance capacity of a transformer) If the error display occurs frequently, or every time, the installation must be checked. If the installation is fault-free, there is a device fault. Check all connection terminals from the device to the grid connection. A fluctuating or missing AC voltage can indicate this connection problem.	B
204			Protection shutdown grid volt. L2	See description in the event of an error 203	See action in the event of an error 203	B

No.	Grid LED	LED	Display	Status description	Action	Pers
205			Protection shutdown grid volt. L3	See description in the event of an error 203	See action in the event of an error 203	B

**NOTE****Fault number not found?**

If fault numbers are displayed on the device but are not listed here, then it is usually necessary to have this looked at by your installation partner.

12 Decommissioning and dismantling

12.1 Switching off the device



⚠ DANGER

Lethal voltages are still present in the connections and cables of the device even after the device has been switched off and disconnected!

Severe injuries or death may occur if the cables and/or terminals/busbars in the device are touched.

1. Comply with all safety regulations and current technical connection specifications of the responsible power supply company.
2. The device is only permitted to be opened or serviced by a qualified electrician.
3. Switch off the grid voltage by turning off the external circuit breakers.
4. Do not touch the cables and/or terminals/busbars when switching the device on and off.
5. Keep the device closed when in operation.



⚠ DANGER

Destruction of the DC plug connectors

DC plug connectors can be destroyed by arcing if disconnected while still live. It is absolutely essential that the following shutdown sequence be carried out in the correct order:

1. Check that there is no current in any of the DC cables using a clip-on ammeter.
2. Disconnect all DC connections one by one.



⚠ WARNING

Risk of burns caused by hot housing components

Housing components can become hot during operation.

1. › During operation, only touch the housing cover on the device.

12.2 Disconnecting connections

12.2.1 AC connection

⌚ It has been ensured that there is no AC/DC voltage present.

1. Undo the 4 screws and carefully remove the housing cover [X_T_30].
2. Unfasten the cables (L1/L2/L3/N/PEN) from the AC connection terminal [X_T_45].
3. Detach the PE line from the earthing bolt [X_T_20].
4. Unfasten the cable fitting and remove the cables through the cable fitting [X_W_36].

12.2.2 DC connection



⚠ DANGER

Destruction of the DC plug connectors

DC plug connectors can be destroyed by arcing if disconnected while still live. It is absolutely essential that the following shutdown sequence be carried out in the correct order:

1. Check that there is no current in any of the DC cables using a clip-on ammeter.
2. Disconnect all DC connections one by one.

- ⌚ Ensure there is no AC/DC voltage present.
- ⌚ Check that there is no current using a clip-on ammeter.
- ⌚ **NOTE: Plug connectors may be unplugged under voltage, but never under load.**
 1. Use a screwdriver (blade width 3 mm) to push out the latch on the coupling.
 2. Leave the screwdriver in place.
 3. Disconnect the DC connector from the DC socket.

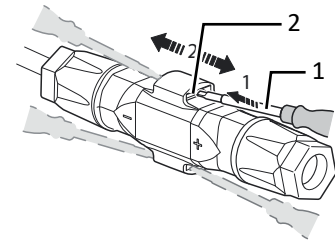

Fig. 62: Unplugging the plug connector

- 1 Screwdriver
- 2 Latch

12.3 Uninstalling the device



⚠ DANGER

Dangerous voltage due to two operating voltages

Severe injuries or death may occur if the cables and/or terminals/busbars in the device are touched. The discharge time of the capacitors is up to 5 minutes.



1. Only appropriately qualified electricians authorised by the mains supply network operator are permitted to open and maintain the device.
2. Before opening the device: Disconnect the AC and DC sides and wait at least 5 minutes.

- ⌚ Device disconnected and secured against restart.
 1. Undo the 4 screws and carefully remove the housing cover [~~X~~T_30]
 2. Remove the interface cables.
 3. Open the AC cable lock on the printed circuit board connection terminal.
 4. Detach the equipotential bonding cable from the grounding point [~~X~~T_30]
 5. Detach the interface cables from the printed circuit board connection terminal.
 6. Detach from the DC cables from the DC plug connectors and furnish with protective caps.
 7. Open the cable fittings [~~X~~W_46 / ~~X~~W_29 / ~~X~~W_20].
 8. Pull the cables out of the device.
- ⇒ The device is uninstalled. Proceed with disassembly.

12.4 Disassembling the device

- ⌚ Unit has been switched off and uninstalled.
 1. Remove the screw that prevents the device from being lifted off the mount.
 2. Use the lateral openings and lift the device off the mount.
- ⇒ Device removed. Proceed with the packaging process.

12.5 Packaging the device

- ⌚ Device has been uninstalled.
 1. If possible, always pack the device in the original packaging. If this is no longer available, an alternative is to use equivalent packaging.
 2. You must be able to close the box completely and it must be able to accommodate the weight and size of the device.

12.6 Storing the device



NOTE

Property damage as a result of condensation

Faulty storage can form condensate in the device and impair the device functioning (e.g. storage outside the ambient conditions or temporary relocation from a cold to a hot environment).

1. Prior to installation, check the inner area for condensation and if necessary, allow it to dry sufficiently before installation.
2. Store in accordance with the technical data > [See section 4.3 ▶ Page 13]

↻ Device packaged.

☞ Store the device at a dry location, in accordance with the ambient temperature range [See section 4.3 Page 13].

13 Disposal



CAUTION

Risk to the environment if disposal is not carried out in the correct manner

For the most part, both the device and the corresponding transport packaging are made from recyclable raw materials.

Unit: Do not dispose of faulty devices or accessories together with household waste. Ensure that the old devices and any accessories are disposed of in a proper manner.

Packaging: Ensure that the transport packaging is disposed of properly.

14 Service and warranty

If you need help solving a technical problem with one of our KACO products, please contact our service hotline.

Please have the following information ready so that we can help you quickly and efficiently:

- Device name / serial number
- Date of installation / Start-up report
- Fault message shown on the display / Description of the fault / Did you notice anything unusual? / What has already been done to analyse the fault?
- Module type and string circuit
- Consignment identification / Delivery address / Contact person (with telephone number)
- Information about the accessibility of the installation site.

You can find the following items and other information at our web site Kaco-newenergy:

- our current warranty conditions,
- a complaint form,
- a form for registering your device. Please register your device without delay. In this manner, you can assist us in providing you with the quickest service possible.



NOTE

The maximum length of the warranty is based on the currently applicable national warranty conditions.

15 Appendix

15.1 EU Declaration of Conformity

Manufacturer's name and address
 KACO new energy GmbH
 Werner-von-Siemens-Allee 1
 74172 Neckarsulm, Germany, Germany

Product description
 Photovoltaic feed-in inverter

Type designation [KACO article No.]	KACO blueplanet 15.0 TL3 M2 WM OD IIGO	[1001614; 1001674; 101853]
	KACO blueplanet 20.0 TL3 M2 WM OD IIGO	[1001453; 1001615; 1001673; 1001831; 1001843; 1001854]
	KACO blueplanet 20.0 TL3 M2 WM OD JPGX	[1001631]

This is to confirm that the units listed above comply with the protection requirements set forth in the Directive of the Council of the European Union of 26th February 2014 on the harmonisation of the laws of the member states relating to Electromagnetic Compatibility (2014/30/EU) and the Low Voltage Directive (2014/35/EU).

The devices conform to the following standards:

2014/35/EU

Safety of the device

"Directive relating to electrical equipment designed for use within certain voltage limits"
 EN 62109-1:2010
 EN 62109-2:2011

2014/30/EU

„Directive relating to electromagnetic compatibility“

Interference immunity

EN 61000-6-2:2005+AC:2005

Emitted interference

EN 61000-6-3:2007 + A1:2011 + AC:2012

Secondary effects on the grid

EN 61000-3-12:2011

EN 61000-3-12:2011

The types mentioned above are therefore labelled with the CE mark.

Unauthorised modifications to the supplied devices and/or any use of the devices that is contrary to their intended use render this Declaration of Conformity null and void.

This declaration of conformity is issued under the sole responsibility of KACO new energy GmbH.



3010898-06-210422